

*A GIS-Based Material Stock-Flow Analysis of Antigua & Barbuda Through the
Lens of the Built and Socio-Economic Environment*

by

Johnella Bradshaw

A thesis
presented to the University of Waterloo
in fulfillment of the
thesis requirement for the degree of
Master of Environmental Studies
in
Sustainability Management

Waterloo, Ontario, Canada, 2019

© Johnella Bradshaw 2019

Author's Declaration

I hereby declare that I am the sole author of this thesis. This is a true copy of the thesis, including any required final revisions, as accepted by my examiners.

I understand that my thesis may be electronically available to the public.

Abstract

Small island developing states (SIDS) in the Caribbean are centered around a service-based economy, where the built environment (or material stocks) functions as the backbone of their social and economic wellbeing. The sensitivity of island economies to both internal and external shocks and vulnerabilities leads to an important question: Can a small island developing state, such as Antigua and Barbuda be sustainable? In the midst of growing climate threats, SIDS have proven to be highly vulnerable to extreme weather events. As a result, there is an urgency to build resilience amongst these island states, with special focus towards the built environment. This research examines the adoption of a Geographical Information Systems (GIS) based methodological approach in analyzing the trends of material stocks (MS) and flows of critical construction materials (aggregates, timber, concrete, and steel) used in buildings on the island of Antigua & Barbuda (A&B). In a bottom-up stock-driven approach, GIS and census data are incorporated through the use of physical parameters pertaining to the building size, (material intensity, number of floors, and the gross floor area) as a means to conduct a material stock analysis. For 2004 the total MS in buildings was estimated at 4,698 kilotonnes (kt), equivalent to 58.5 tonnes per capita. The main construction material of the MS consisted of non-metallic minerals (2,898 kt), followed by aggregates (1,176 kt), steel (443 kt), and timber (181 kt). The gross addition to stock (GAS) from 2006 to 2017 equaled to 3,480 kt with an average of 348 kt of construction materials added per year. A sea level rise analysis aimed to assess the extent of vulnerability the built environment was exposed to on the island. Under a 2-meter rise scenario an estimated 198 kt of material stock would be exposed, equivalent to 4.2% of the island's total MS. The tourism industry accounts for 80% of A&B's GDP and experienced the greatest exposure of 19% of the coastal industry's MS. This research emphasizes the extent of environmental and economic vulnerability and examines the role between the interrelationship of material stocks-flows-services in A&B, from a socio-economic and ecological perspective. This study makes a contribution by emphasizing the role that material stock accounts can play in understanding island sustainability through the development of disaster management risk information, providing insight to policy makers on resource use dynamics base on spatial analysis and adequate physical infrastructure planning.

Keywords: Small island developing states (SIDS), sustainability, material flow analysis, material stock, services, construction materials, geographical information systems (GIS)

Acknowledgement

It is without any doubt that I would not have been equipped to complete this instrumental milestone if it was not for the network of valuable people providing me with their continuous support and guidance throughout this journey.

I would first like to thank my supervisors Prof. Simron Singh and Dr. Su-Yin Tan. The hope and faith you both have embedded in me from day one has been an essential driving force towards my success. It provided me with the fuel not only to continue this race, but to cross the finish line despite the obstacles in my path. My committee would not have been complete without Tomer Fishman. The distance that divided your physical presence here in Waterloo, never interfered with your ability to provide me with the necessary feedback, and in keeping me in sync with my end goal. You have never failed to provide your constant support and time, for this I am eternally grateful.

To Kristen and Sam, thanks for the helping hand in the lab and aiding in my steep learning curve with Arc GIS and R-coding. You both were always there for me when I needed you, including the good and bad days.

Aisha, Leonardo, Shanee, Danielle, Yumani, and Thea, thank you all for friendships that have no boundaries. The continuous encouragement effortlessly given to me in these previous years is one I cherish and will not take for granted.

To mom, dad, and Dr. Hope, I would not have made it this far in my life if it was not for your love and everlasting support. The countless hours, sacrifices, and phone calls were not in vain. Thanks for providing me with the opportunity to pursue my dreams. In knowledge there is power, and each one of you have provided me with the tools to better myself in this world. I love you all to the end of time.

To my family at the DMU of the Department of Environment and National Statistics Office in Antigua & Barbuda, I appreciate the data sets given to me. Without data there would not be any research. Much gratitude is given to your willingness to assist me in whatever capacity available. This journey would not have been possible without my SUSM cohort, to each and every one of you who made this experience more than I ever thought it could be, thank you!

Table of Contents

<i>Author’s Declaration</i>	<i>i</i>
<i>Abstract</i>	<i>ii</i>
<i>Acknowledgement</i>	<i>iii</i>
<i>List of Figures</i>	<i>vii</i>
<i>List of Tables</i>	<i>x</i>
1 Introduction	1
1.1 Global Material Consumption and Sustainability	1
1.2 Island Sustainability Material-use and services: Vulnerability of Small Island States	2
1.3 Research Objectives	4
1.4 Study Area	5
1.5 Thesis Structure	9
2 Literature Review	10
2.1 Socioeconomic Metabolism and Sustainability	10
2.1.1 Why does the society-nature interaction matter?	10
2.1.2 The Role of MFA: The Economy and the Environment.....	11
2.2 Stocks, Flows, and Services within the Economy	13
2.2.1 Why is it important to represent stocks?.....	13
2.3 Circular Economy: Closing the Loop	14
2.4 Research in Material Flow Analysis used to Estimate Material Stocks	17
2.5 Top Down Approaches	18
2.5.1 Bottom-up Approaches	20
2.6 Research adopting a GIS-based material flow analysis and alternative approaches	21
2.7 Sea Level Rise Methodological Approach	23
2.8 Material Stock Research Findings	24
2.9 Island vulnerability: The link between climate and socioeconomic vulnerability	27
2.9.1 Extreme Weather Events: Historical trends of storms	27
2.9.2 Climate Vulnerability and its influence on the socio-economic systems within the island context.....	30
2.9.3 Island Sustainability: Industrial Ecology through the lens of Material Stock and Building Infrastructure Resiliency	32
3 Methodology	33
3.1 Methodology for material flow analysis (MFA)	34
3.1.1 Spatial and Temporal Scale	35
3.1.2 MFA Indicators for construction material flows.....	36
3.1.3 Data sources.....	37
3.1.4 Trade Data	38
3.1.5 Domestic Extraction	39
3.1.6 Grossed Addition to Stock (GAS) based on domestic material consumption (DMC) values.....	40
3.1.7 Net Additions to Stock (NAS)	41
3.2 Social and Ecological Performance	41

3.3	Methodology for material stock analysis (MSA) of buildings	43
3.4	Building footprint classification	45
3.4.1	Building use type classes	48
3.5	Material Intensity Typology	51
3.6	Height Assumptions	52
3.7	Field Work and Building Height Assumptions	54
3.8	Residential Material Intensity Distribution	56
3.9	Mapping Spatial Distribution	57
3.10	Estimating Vulnerable Building Stock	58
3.10.1	Sea level Rise Analysis	58
4	Results	60
4.1	MFA of construction materials (2006-2017)	60
4.1.1	Imports	60
4.1.2	Exports	61
4.1.3	Physical Trade Balance (PTB).....	62
4.1.4	Domestic Extraction (DE)	63
4.1.5	Domestic Material Consumption (DMC)	64
4.1.6	Gross Addition to Stock (GAS)	65
4.1.7	Net Addition to Stock (NAS).....	68
4.2	Building Permits and Construction and Demolition (C&D) Waste	68
4.3	Environmental and Social Performance	70
4.4	Material Intensity Typologies and Height Assumption	71
4.5	Residential Material Intensity and Height Assumptions	73
4.6	Material Stock (MS) of Buildings	76
4.6.1	Material Stock Divided by Building Use-Type	76
4.6.2	Spatial Distribution	79
4.7	Material Stock Vulnerability: Flood Risk Map & Sea Level Rise (SLR)	83
4.7.1	Flood Risk Map	83
4.7.2	Sea Level Rise (SLR)	84
5	Discussion	87
5.1	Antigua & Barbuda’s material stocks and flows: Per capita level of Material-Use and the Physical Economy	87
5.2	Spatial distribution of the building stock- The importance of building resilience	92
5.3	Tourism and Material Stocks	93
5.4	Limitations and Future Work	96
6	Conclusion	100
7	Bibliography	103
8	Appendix	115
8.1	Data Quality Assessment	115
8.2	Material Intensity Typology Calculations	117

8.3	Code used in the Monte Carlo Simulations for the Random Assignment of Material Intensity Typologies within the Residential Sector.....	131
8.4	Timeline of Hurricanes and Tropical Storms in A&B from 2006-2017.	133
8.5	Tourist arrivals compared with local population.	134
8.6	Construction Material Codes and Description.	134
8.7	Database of collected information for Antigua & Barbuda.....	138

List of Figures

<i>Figure 1: A map of Antigua & Barbuda.</i>	6
<i>Figure 2: Describes the economy-environment interactions, with the economy presented as a subset of the environment. This figure is adapted from Pauliuk et al. (2015) and Korhonen et al. 2018.</i>	12
<i>Figure 3: Stock-flow relations in socioeconomic metabolism modified and adopted from Haberl et al., 2017.</i>	13
<i>Figure 4: The conceptual framework of a circular economy Korhonen et al. 2018).</i>	15
<i>Figure 5: A schematic diagram of the economy-wide material flow accounting (EW-MFA) conceptual framework modified from Wiedenhofer et al. (2019).</i>	35
<i>Figure 6: A general overview of the GIS adapted methodology used in calculating the building Material Stock and Sea level Rise Analysis in Antigua & Barbuda.</i>	43
<i>Figure 7: Features of the Image Interpretation and analysis of remote sensing imagery for classifying building footprints in Antigua & Barbuda.</i>	46
<i>Figure 8: Key elements analysed by the researcher through the image interpretation of Antigua & Barbuda's building footprints.</i>	48
<i>Figure 9: Height data assumption of the building footprints within the parish of St. John's, Antigua & Barbuda.</i>	53
<i>Figure 10: Spatial Distribution of the data collection points of each building footprint visited in Antigua & Barbuda.</i>	55
<i>Figure 11: Illustrates the quantity of wood, non-metallic minerals, iron, steel and other metals imported into Antigua & Barbuda on the primary axis from 2006 to 2017.</i>	61
<i>Figure 12: The percentage breakdown of imported construction material into Antigua & Barbuda from 2006-2017.</i>	61
<i>Figure 13: A breakdown of the four main categories of construction materials exported from 2006 to 2017 in Antigua & Barbuda: A represents non-metallic minerals, B represents wood, C represents iron and steel, and D represents other metals. Note the difference in scales.</i>	62
<i>Figure 14: The Physical trade balance of construction materials imported and exported within Antigua & Barbuda from 2006-2017 plotted on the primary axis (right).</i>	63
<i>Figure 15: The percentage of construction materials contributing to the Physical Trade Balance (PTB) in Antigua & Barbuda from 2006-2017.</i>	63
<i>Figure 16: The domestic extraction of non-metallic minerals from 2006 to 2017 in Antigua & Barbuda.</i>	64
<i>Figure 17: The distribution of sand and gravel used within different components of the built environment from 2006-2017 in Antigua and Barbuda.</i>	64
<i>Figure 18: DMC and GDP are plotted on the right (primary) axis and material productivity (GDP/DMC) is plotted on the left (secondary) axis for Antigua and Barbuda from 2006 to 2017.</i>	65

<i>Figure 19: A Breakdown of the different categories of construction materials comprising the total Gross addition to Stock (GAS) in Antigua & Barbuda from 2006 to 2017.</i>	66
<i>Figure 20: The distribution of gross addition to stock, compared between domestic extractions and the physical trade balance in Antigua & Barbuda from 2006 to 2017.</i>	66
<i>Figure 21: The trends observed within the Gross Addition to Stocks (GAS) for the four categories of construction materials in Antigua and Barbuda from 2006 to 2017. Note the different scales.</i>	67
<i>Figure 22: The trends in Net addition stocks (NAS) plotted on the right axis and the growth rates of NAS per capita plotted on the left axis for Antigua and Barbuda between 2006-2016.</i>	68
<i>Figure 23: The total square footage of new residential and commercial buildings plotted on the primary axis (left) and the total number of approved building plans on the secondary axis (right).</i>	69
<i>Figure 24: Construction and Demolition (C&D) waste collected in Antigua & Barbuda is plotted on the left axis from 2006 – 2016.</i>	69
<i>Figure 25: The confidence intervals centered around the population mean for randomly assigning the material typologies within the residential building use-type class through the Monte Carlo simulation.</i>	74
<i>Figure 26: Breakdown of the total estimated MS (4,698 kilotons) by material category in Antigua & Barbuda for 2004.</i>	76
<i>Figure 27: The total percentage of the building material stock separated by building use-type categories in Antigua & Barbuda for 2004.</i>	77
<i>Figure 28: GDP contribution broken down by economic activity plotted on the left (primary) axis and GDP values plotted on the right (secondary) axis in Antigua & Barbuda from 2006-2017.</i>	77
<i>Figure 29: Building Material Stock broken down by material category (percentage%) in Antigua & Barbuda for 2004.</i>	79
<i>Figure 30: The spatial distribution of the total material stock (MS) of construction materials within buildings in Antigua & Barbuda (2004).</i>	80
<i>Figure 31: A local-scale distribution of the total amount of concrete(A), steel (B), timber (C) and aggregates (D) respectively within buildings (measured in tonnes) situated in the capital of the country, St. John's.</i>	82
<i>Figure S1: A detailed drawing of the footing detail of a wooden house</i>	120
<i>Figure S2: A typical drawing of a strip foundation (with concrete pillars)</i>	121
<i>Figure S3: A typical drawing of a column pad footing</i>	122
<i>Figure S4: A typical drawing of a pile cap and beam foundation.</i>	123
<i>Figure S5: Typical measurement of a slope of a house</i>	127
<i>Figure S6: Illustrates the individual roof details of a typical Gable roof.</i>	129
<i>Figure S7: An aerial view of a typical Gable Roof.</i>	130

Figure S8: The percentage (%) share of tourist arrival opposed to population size in Antigua and Barbuda from 2006-2017..... 134

List of Tables

<i>Table 1: Major Hurricane Storms and their Cost of Damages experienced by Antigua & Barbuda and the wider Caribbean Region</i>	28
<i>Table 2: A summary of the MFA Indicators and their role in the MFA of Antigua & Barbuda.</i> .	36
<i>Table 3: Eurostat classification of domestic materials, imports, and exports</i>	38
<i>Table 4: Social and Ecological Indicators Used to Examine the Social and Ecological Performance</i>	42
<i>Table 5 :Data files and data sources used for calculating the material stock analysis of buildings in Antigua & Barbuda</i>	44
<i>Table 6: The classification codes and building use-type classes for Antigua & Barbuda.</i>	49
<i>Table 7: A breakdown of the building footprints (BF) visited on the field based on the buildings-use type categories and average number of stories observed</i>	55
<i>Table 8: The distribution of the material intensity typologies within the residential building class based on the outer wall materials of household dwellings</i>	56
<i>Table 9: An evaluation of Antigua & Barbuda's social and ecological performance</i>	71
<i>Table 10: Material Intensity Typologies for Antigua & Barbuda (kg/m²) based on local construction styles</i>	71
<i>Table 11: The percentage change in the total estimated material stock for each building-use type under a (+/-) floor change</i>	75
<i>Table 12: Building material stock per capita, broken down by the building use types and material category. Units t/cap</i>	78
<i>Table 13: Exposed Building Footprint and Material Stock (MS) based on various flood risk levels</i>	84
<i>Table 14: The percentage of exposed material stock within the affected building use-type categories identified in the sea level rise analysis and flood risk assessment</i>	86
<i>Table 15: The residential building material stock of various locations in the literature</i>	87
<i>Table S1: Data quality indicators used in assessing the data uncertainty and reliability of the data sets used in the research.</i>	115
<i>Table S2: Data Quality Results of the MFA Data Set.</i>	116
<i>Table S3: Processing and Manufacturing Loss Rates of Key Building Stock Materials used in estimating loss rates of materials used in domestic extractions (DE) and the gross addition to stocks (GAS)</i>	116
<i>Table S4: A Table of the construction materials codes and description of Material studied within the study sourced from the UN Comtrade database.</i>	134
<i>Table S5: A database of collected information on Antigua & Barbuda used for data analysis.</i>	138

“How can I say thanks for the things You have done for me? Things so underserved, yet You gave to prove Your love for me; the voices of a million angels could not express my gratitude.

All that I am and ever hope to be, I owe it all to Thee.”- Andrae Crouch.

1 Introduction

1.1 Global Material Consumption and Sustainability

Greater interest has been directed towards research focused on the dynamics of material stocks within buildings (Kleemann, Lederer, Rechberger, & Fellner, 2017). The building industry has transformed into one of the most essential components within the economy in present day societies. By its growing size, the construction sector plays a crucial role in adding to the existing building stock worldwide, and functions as one of the largest consumers of energy and natural resources (Akadiri, Chinyio, & Olomolaiye., 2012). The amount and type of materials required by the construction sector has substantial ramifications on the environmental impact of buildings (Heeren & Hellweg, 2018; Akadiri et al., 2012). As there are growing concerns regarding resource scarcity and environmental degradation, the sustainability of built environment plays a pivotal role in achieving sustainable development. The focus surrounding construction materials stems from the consequences of unsustainable resource extraction and consumption, with a 10-fold rise in material use observed from 1900-2010 growing from 7 thousand (megatonnes/year) Mt/yr to 79 thousand Mt/yr (Krausmann et al., 2017). The construction sector is responsible for consuming at least 50% of the materials extracted from the earth, inclusive of the 48 billion tonnes increase of materials extracted throughout the twentieth century (Hu et al. 2010).

General issues surrounding this vast growth in material extraction and use includes the quantity, type and quality of materials consumed, as well as the production and manufacturing use of secondary derived materials. The end of life management and disposal of these materials are an added layer of concern, in relation to major themes such as waste minimization, waste management and material recoverability (Kleemann et al. 2017; Anderberg, 1997; Pelling & Uitto, 2001). To minimize the high flows of Construction and Demolition (C&D) waste, a transition is required from a linear waste stream to a closed loop system (Tingley, Arbabi, & Durkin, 2017). In response to the increasing demand of future construction materials, the mineral component of C&D waste can function as a secondary source for a mineral depository within the construction industry (Kleemann et al. 2017). Hereby reducing the industry's overall reliance on raw primary construction minerals used to supply materials such as cement, asphalt, crushed stone, sand and gravel that predominantly contributes to the growing stock of materials within the economy (Hashimoto, Tanikawa, & Moriguchi., 2006). Sev., (2009) adopts a life-cycle perspective to

implement sustainability principles within the construction industry based on three core principles including: resource management, life cycle design and design for human and environment interaction. Although this study is not focused on life cycle design principles, it illustrates why studying resource flows and material stocks is a critical component within resource management and why understanding the nature-human interaction is essential to reduce negative social and environmental impacts of providing services.

These concepts surrounding material use align with Sustainable Development Goal 12, which focuses on responsible production and consumption of materials and natural resources. In response to the increasing global material use, construction non-metallic minerals were identified as the fastest growing materials from 1970 to 2010 within the construction industry (UNEP, 2016). The concept of sustainable consumption and production (SCP) was developed in response to the heightened increase of material consumption, which focuses on socio-economic activities and their environmental impacts (Akenji & Bengtsson, 2014). The coupled relationship between economic activities and material extraction indicates that the world's growing economy is heavily reliant on a substantial supply of materials from the environment (UNEP, 2016). Therefore, taking steps to decouple economic activity from the rising rate of natural resource consumption becomes a critical component in achieving sustainable development (UNEP, 2016). Furthermore, an absolute global reduction in raw material is essential in strategizing sustainable development (Wiesen & Wirges, 2017). Decoupling can reduce the amount of natural resources used per unit of economic activity, which is termed as resource decoupling, when faced with issues of resource depletion (UNEP, 2011). In contrast, impact decoupling caters towards decreasing the negative environmental impacts whilst increasing economic output (UNEP, 2011). This provides a platform catered towards creating innovative technological solutions curated for reducing environmental threats and hazards associated to the continuing extraction of natural resources (UNEP, 2011).

1.2 Island Sustainability Material-use and services: Vulnerability of Small Island States

Through the lens of industrial ecology, human well-being is not only linked to material extraction and resource consumption, but it includes the use of physical services provided by material stocks or commonly referred to as “in-use material stocks” (or short: “material stocks”) (Pauliuk & Muller, 2014). Material stocks are representative of the physical infrastructure used for consumption and production, hence viewed as “the material basis of societal well-being” (Haberl,

Wiedenhofer, Erb, Georg & Krausmann., 2017). Material stocks can be described as materials which flows into a system, builds up and maintains the system's material compartment (Fischer-Kowalski et al., 2011). The material stocks are not only restricted to the basic needs of society, but it provides goods and services incentivizing economic growth. Material flows within the economy provide a fundamental understanding on resource related environmental issues through quantifying and identifying consumption and production patterns (Vilaysouk, Schandl, Murakami., 2017).

SIDS are home to approximately 65 million people and are highly vulnerable to climate change. These island states are expected to be disproportionately affected by climate change impacts, with some islands becoming uninhabitable (UNFCCC, 2007). Small island developing states (SIDS) are characterized by a unique set of characteristics outlining natural, social and economic factors threatening the island's socio-economic system. The extent of vulnerability on SIDS can be exacerbated through additional factors including: geographical isolation, the concentration of settlements and their associated social and economic activities within close proximities of the coast, coral bleaching, coastal erosion, tropical storms and cyclones, storm surges, the presence of low-lying coastal and flood prone areas, and exposed population and infrastructure which can result in high cost of damages within the socio-economic infrastructure (Mirza, 2013; UNFCCC, 2007). In face of these threats, achieving island sustainability is critical for these SIDS. Island sustainability examined through the scope of this study is defined as increasing the island's resiliency against economic and environmental vulnerabilities to meet the needs of the present, without compromising the ability to meet the needs of future generations. Through quantifying material flows and mapping the spatial distribution of the building material stocks it provides a means for developing adaptive capacities in identifying and eliminating maladaptive practices. The removal of maladaptive practices results in activities focused on adaptation (UNFCCC., 2009). This includes the identification of vulnerable areas and at-risk hotspots within these islands where limited infrastructure development should be occurring within highly threatened areas. This analysis can assist in disaster management, through assessing the magnitude of vulnerability on multiple layers including the building use type of the material stocks, type of construction materials and the services associated with the built stock and the potential loss of materials post disaster.

SIDS's have a high degree of vulnerability to extreme weather events within a fragile ecosystem and economy such as those islands within the Caribbean region, where the damages incurred from climate related events are significant according to their size of their economies (Deschenes & Chertow, 2004;UN-OHRLLS., 2015). In terms of loss and cost, storms are the costliest climate related disaster accounting for 61% of the reported losses in low income countries (CRED., 2018). Ten percentage of the worst affected countries impacted by climate related disasters are reported in the Caribbean where losses are measured in relation to the country's GDP. The high cost of loss and damage is accompanied by high debt levels, and the reliance on external import flows from other countries to support local resource demand for reconstruction and infrastructure development. For example, in 2017 as a consequence of the passing of hurricane Maria, Sint Maarten's losses relative to GDP was 797%, for the British Virgin Islands it was the country experienced a total sum of loss and damage equivalent to 309%, and for Dominica 259% of their GDP (CRED., 2018 & UNISDR., 2018). Additionally, these SIDS are vulnerable through their limited access to social, environmental, economic, geographical and political assets (Pelling & Uitto. 2002). Through further research on disaster impacts, Pelling and Uitto (2002) indicated that small islands like Antigua & Barbuda usually experience the highest relative losses through a single extreme disaster. These losses are directly tied to the building stock providing the socio-economic environment with critical goods and services. Therefore, advocating for greater disaster management and infrastructure resiliency to protect the vital services provided by material stocks within the local economy through attaining island sustainability. Island sustainability is focused on achieving sustainable action tailored towards buffering against or adapt to the adverse impacts threatening the socio-economic systems such as climate vulnerability or the lack of diversification in economic activities. In the Caribbean, the cost of inaction by 2050 will amount to 10% of the region's current economy size (UN-OHRLLS.,2015).

1.3 Research Objectives

This study adds to a novel area of research expanding knowledge on the metabolism of islands. Special focus is directed to estimating the built material stock on a national level. Understanding the material stock flows of key construction materials within climate vulnerable islands can act as indicator of sustainability in predicting current and future flows (Symmes, et al., 2019). Small islands are ideal places to study stocks and flows as they are uniquely defined through their high degree of isolation, limited carrying capacity, restricted access to resources, and climate

sensitive economic activities (Taylor et al. 2018; Hay, 2013; CIDA. 2004; Pichler & Striessnig, 2014). Antigua & Barbuda, just like any other SIDS in the Caribbean, is no different. The study focuses on examining the influence of socio-economic variables and climate vulnerabilities on the material stock-flow relationship of construction materials in Antigua & Barbuda. The study adopts a geospatial analysis in mapping and assessing the vulnerability of material stocks.

In this single industry driven country, the study seeks to answer the following overarching research questions:

RQ1: “How to analyze the interaction between environmental and social performances in Antigua & Barbuda from a material stock flow perspective?”

RQ2: “How can resource use patterns within Antigua & Barbuda be leveraged to support the growth in the building material stock?”

The four main objectives of the research are as follows:

- a) Conduct a material flow analysis of construction materials.
- b) Map and quantify the spatial distribution of accumulated construction materials in buildings.
- c) Assess the vulnerability and loss of construction materials to potential sea level rise scenarios.
- d) Identify factors within the socio-economic environment driving the growth and accumulation of construction material within Antigua & Barbuda.

The research is based on the following sub-questions:

1. What is the quantity of construction material added to the building stock of Antigua from a material flow analysis from 2006-2017?
2. What and where are the concentrations of material stocks in Antigua?
3. To what extent are the material stocks threatened by sea level rise?
4. What driving factors are influencing the accumulation of material stocks within the built infrastructure of Antigua & Barbuda?

1.4 Study Area

Antigua & Barbuda is one of the Leeward Islands situated in the eastern Caribbean Sea (Organization of Eastern Caribbean States, 2019). The country’s political boundary is comprised of three islands: Antigua, Barbuda, and Redonda. Antigua functions as the mainland territory, and

is the largest of the three with an area of 280 sq. km. The sister isle of Barbuda is the second largest with an area of 161 sq. km. The smallest of the three, Redonda is the only uninhabited island with an area of 1.6 sq. km (Commonwealth, 2019). The population of the twin island state in 2017 was estimated at 95,426 with over 97% of the population residing in Antigua and the remaining 3% on Barbuda (World Bank, 2017). The population in comparison to the country's size, equates to a population density of 216 persons per sq. km (World Bank, 2017). Antigua's landscape is divided into seven parishes with St. John's being Antigua's capital city, and Codrington being the capital of Barbuda as seen in Figure 1.



Source: University of Texas (2012).

Figure 1: A map of Antigua & Barbuda.

Population is not evenly distributed within the island as 61% of the population and houses are situated within the parish of St. John, as well as the main commercial hub being situated within St John's city. The parishes of St. George, St. Paul, and St. Mary contain approximately 30% of the total buildings and housing. Based on the 2011 census, the most prevalent building materials were wood measuring at 41% followed by concrete measuring at 39%. In comparison 70 % of the buildings in Barbuda consisted of concrete and block while 21% consisted of wood and other materials.

The coupled relationship between the ecosystem and the economy, has proven to be beneficial in sustaining economic growth in Antigua & Barbuda. The country's limited natural resources, distinct ecosystems, and its rich cultural heritage are all contributing factors in sustaining the island's economy. Historically, economic growth was driven by agricultural products such as rum and sugar, but within the past decades both agricultural and manufacturing activities have been on a drastic decline. Economic driving forces have transitioned towards a more service-based economy with the provision of services on the island contributing to 90% of the country's GDP over the past forty (40) years, as a result of the expanding tourism industry (Eastern Caribbean Central Bank, 2019; UNEP, 2011b). Other service orientated industries present in the twin island state includes real estate, renting, and banking activities, hotels and restaurants, wholesale and retail trade and transport, storage, and communications.

The World Bank Group reports that tourism accounts for approximately 80% of the gross domestic product, 85% of the foreign exchange, and contributes to 70% of direct and indirect employment. Antigua & Barbuda's desirable climate provides perfect conditions to support its dominant and flourishing sand, sun, and, sea tourism industry. UN- OHRLLS., (2015) showed that Antigua & Barbuda had the highest share of tourism in GDP amongst the tourism-dependent islands within the SIDS. However, with the country being based on a single driven economy, the lack of diversity translates to the lack of economic resiliency. The built environment plays a critical role in providing key services driven by the tourism industry. Services including hotel accommodations, restaurants, real estate, yachting and marina facilities, which they are also linked to the expansion of the transportation infrastructure permitting greater accessibility around the island for both locals and tourists. The growth and expansion of material stocks are demonstrative of the physical materials required for society's growth and prosperity (Haberl, Wiedenhofer, Erb, Georg & Krausmann., 2017).

However, small island developing states are illustrative of places of vulnerability (Campbell, 2009). With a heavy reliance on climate sensitive economic activities, material stocks are severely threatened by extreme weather events (Taylor et al. 2018). The World Bank's analysis of climate change forecasts in the island, covers three main topics:

- 1 Coastal erosion
- 2 Rainfall intensity
- 3 Storm intensity

Accelerated coastal erosion, increased rainfall intensity (resulting in flooding) and increased tropical storm intensity are projected for the twin island state, thus cautioning for greater resiliency in restructuring the physical infrastructure. During the 2017 Atlantic hurricane season, housing and infrastructure were identified as the two most severely affected sectors in the Caribbean (UNDP, 2017). The cost to recover these sectors is estimated to be above USD 109 million dollars (UNDP, 2017). Destroyed material stock and debris hinder the provision of essential goods and services vital to the socio-economic environment which can stunt economic growth on SIDS. From an economic lens this is illustrated within the tourism industry which is entirely dependent on materials stocks. After disaster has struck and material stocks are rendered useless, it decreases the ability and capacity for the country to return to its regular state of operation and in accommodating its normal flow of tourists into the island, thus directly harming the country's main source of revenue. From a social perspective, people and families are displaced through severe structural damage experienced nation-wide as well as on an individual scale through the loss of homes. Basic amenities and services become inaccessible including transport, electricity, and water services. Individuals are unable to return to work, where the majority are workers employed within the tourism sector, government institutions and ports of entry.

Geographical Information Systems (GIS) is a technological tool used to understand the relationship between geography and effective decision making (ESRI, 2012). Through the context of sustainable development GIS software allows for greater understanding of the growing pressure and demand placed on the natural environment to produce more resources for a growing population. Therefore, emphasizing on the need for sustainable initiatives and practices. GIS particularly focuses on spatially referenced data that is used to monitor and manage natural resources at multi-temporal and multi-spatial scales (Bateman et al., 2002; Kumar, Yamac, & Velmurugan., 2015). Baharie and Elliott-White., (1999) discussed critical questions asked and analysed using GIS, they include:

- Location- What is at? - What material stocks are located on the coastal region?
- Condition- Where is it? - Where are residential stocks accumulated in comparison to commercial stocks?
- Pattern- What is the pattern? - Analyze the relationships between services and material stocks?

- Trend- What has changed? – How has economic activity influenced the growth of material stocks within the socio-economic environment?
- Modelling- What if? - What is the percentage of material stocks threatened by a 2 m sea level rise or intense flooding?

The application of GIS used in analyzing material stock accounts, can assess environmental conditions in relation to resource use, the feasibility of proposed developments, and possible conflict of interest between human-nature relationship (Baharie & Elliott-White., 1999).

Through the context of climate change spatial data and spatial analysis can be used as a tool facilitating in mitigating climate change and adapting to unavoidable events such as addressing spatial planning issues with respect to sea level rise or increased flood risks threatening vulnerable low-lying areas (Hurlimann & March., 2012). To minimize that impacts of climate change within the built environment, infrastructure development needs to be adjusted to cater to and buffer against these adverse changes, as well as identifying vulnerable communities. Material stocks are directly threatened by climate change and extreme events with the critical services that they provide within the social system and natural environment that are consequently faced with high risk levels. Through spatial analysis and geographic location of each building the spatio-temporal patterns of stocks and flows can be quantified and used in comprehending and governing the social metabolism within socioeconomic systems (Liu, Chen, Lin & Gao., 2019).

1.5 Thesis Structure

The thesis begins with an in-depth analysis of the theoretical framework supporting the material-stock flow perspective in the literature review of Section 2. Section 3 discusses the role of the different methodologies adopted in tracking the material flows in and out the country, quantifying and mapping the building material stock, and outlining the steps taken in assessing the material stock vulnerability. Section 4 follows directly after the methodology, to present the research results and analysis. To expand on the results, Section 5 examines the main findings in comparison to those of other studies, with research limitations and further work reviewed. To conclude, Section 6 ends with a brief summary of the research scope and its purpose examined throughout the entire thesis.

2 Literature Review

2.1 Socioeconomic Metabolism and Sustainability

2.1.1 *Why does the society-nature interaction matter?*

Socio-economic metabolism (SEM) at its core is a conceptual framework used to track material flows (inputs and outputs), processing, transformations, energy use and losses. They are quantified and analyzed from a complex socio-technical lens within and between social systems, as well as the natural environment (Graedel & Lifset, 2016; Haberl et al. 2019). SEM by extension provides a paradigm built on studying the bio-physical basis of the human society, where the society-nature interface is used as a platform to examine rising environmental issues, and to initiate appropriate sustainable measures in response (Pauliuk & Hertwich, 2015a; Fischer-Kowalski & Haberl, 1998; Graedel et al., 2016). The socio-economic metabolism framework is used to ask and answer questions pertaining to why and how economic development is so heavily dependent on the natural environment and seeks to conceptualize underlying factors driving this dynamic relationship. Following the SEM framework, environmental burdens and their associated impacts are determined by the socio-metabolic profile of the society, which is distinguished through analyzing the patterns, size, and composition of social metabolism (Haber et al., 2019). SEM can be differentiated between social units on a local, regional and international scale, based on their society-nature exchange in the form of material and energy throughput (Pauliuk & Hertwich, 2015a; Fischer-Kowalski & Haberl 1998). Metabolism is a biological concept describing the means through which organisms are able to maintain a continuous flow of materials and energy with their environment in order to sustain growth, reproduce, and promote proper function (Fischer-Kowalski et al. 1998; Fischer-Kowalski & Weisz 1999). In comparison, based on this analogy it suggests that through SEM social systems organize material and energy with their natural environment in similar way as with organisms. Through the means of promoting self-preservation and well-being, society domestically extracts raw materials, convert them into goods and services which caters to the society's basic needs. At the end stage of the cycle, the outflow from the system is released back into nature as waste known as the linear flow of materials, if recycling does not occur closing the loop (Fischer-Kowalski & Weisz 1999).

2.1.2 *The Role of MFA: The Economy and the Environment*

Quantitative approaches are seen as an integral part in studying the biophysical basis of society where distinctive industrial ecology tools have been developed and used to expand socio-metabolic research. They include life cycle assessments (LCA), input/output analysis (IO), material and energy flow analysis (MEFA) and material flow stock accounting (MFSA). All tools are used to quantify material use or material throughput through socioeconomic systems at various scales. Material flow analysis is a methodology widely used in tracking the flows, stocks, and losses of a specific material or resources such as metals (Graedel et al., 2016). However, there are different types of MFA that can be used depending on the nature of the research. One of the analytical and measuring tools under the family tree of MFA includes EW-MFA, (economy-wide material flow analysis). EW-MFA measures “the amount of physical inputs into the economy, material accumulation in the economy and outputs to other economies or back to nature.” (Eurostat, 2018b) (p.5). This tool provides an added layer of information to understand the dynamic interrelations between society and nature where material flows and resource consumption are examined within the economy. The integrated view of physical resource flows within MFA can provide quantifiable information on environmental performance such as:

- Inefficient use of natural resources, materials and energy.
- Highlight supply and demand issues of material resources based on trade data
- Measure environmental pressures of resource use with EW-MFA indicators as proxies (OECD, 2008a).

EW-MFA and their specified indicators are outlined in Table 2, as they formulate the core of the EW-MFA framework. They are used to estimate resource extraction, material consumption, material footprints and productivity (Eurostat, 2018b). Resource productivity is used to measure the amount of materials used within an economy in relation to GDP (Eurostat, 2016). Resource productivity or efficiency indicators compare economic growth (GDP) to consumption indicators such as domestic material consumption (DMC), expressed as GDP/DMC . Resource productivity is also used a measure to determine if decoupling occurs between economic growth and resource use.

EW-MFA is a framework that can be easily adopted by countries and regions across multiple spatial scales, presenting a guide and methodological harmonization of core concepts and tools used within socio-metabolic research (SMR). National accounts can be compared to track

the movement of materials throughout social systems on multiple scales. Social metabolism can be viewed as a whole or analyzed through its individual parts in order to understand and achieve sustainable development (Pauliuk et al. 2015a). This is based on the principle that the metabolism of the system comprises the sum metabolism of its compartments (Fischer-Kowalski & Weisz., 1999).

In Figure 2, the interpretation of the economy-environment interaction is widely adopted by ecological economists, and international organisations, such as Eurostat. Figure 2 illustrates the economy as a “physically growing subsystem” of the natural environment, whilst simultaneously acknowledging the physical limitation of the environment (Pauliuk et al., 2015a). Physical limitations within the environment have been discussed in terms of planetary boundaries within the literature. Planetary boundaries are built on the pillars of global sustainability and seek to define non-threatening thresholds for socio-economic activities without threatening earth system processes.

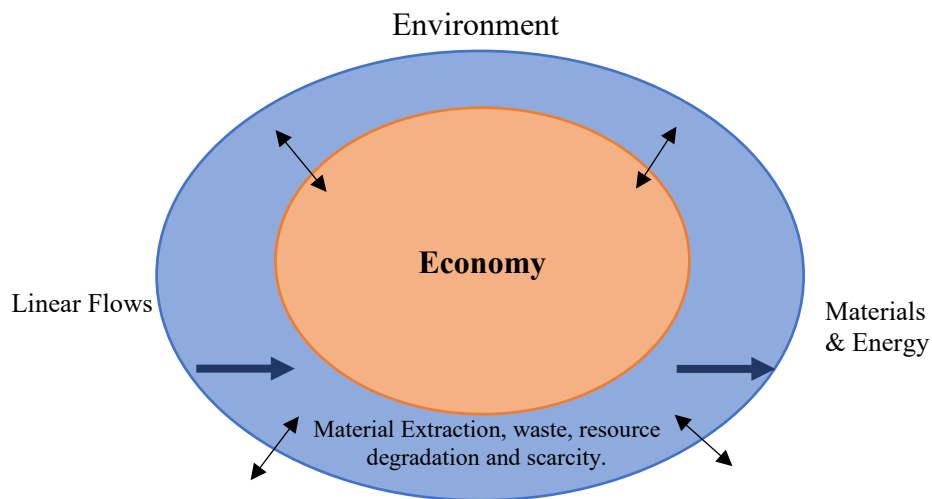

Figure 2: Describes the economy-environment interactions, with the economy presented as a subset of the environment. This figure is adapted from Pauliuk et al. (2015) and Korhonen et al. 2018.

Estimated values determined by these planetary boundaries, stands as a defence into crossing thresholds that will result in disastrous environmental change, therefore establishing a safe operating space for interactions between the economy-environment boundaries (Rockstrom et al., 2009). Korhonen et al. (2018) further elaborated on the natural environment as the parent system which is shrinking in response to the growing economy. In this system, the natural environment plays dual roles: 1) as a source of input for natural resources and 2) as a sink for

outputs through waste generation and emissions (OECD, 2008a), including the consequences of resource overuse. MFA captures these flows in physical units creating a pathway for sustainable transitions within the bio-physical sphere.

2.2 Stocks, Flows, and Services within the Economy

2.2.1 *Why is it important to represent stocks?*

One of the general preconditions for SEM is based on the first law of thermodynamics, which is the law of conservation of energy. The law states that energy can neither be created nor destroyed; energy can only be transferred or changed from one form to another. Therefore, the sum of energy and materials that flows into a system, equals the sum of outputs in addition to the changes in stock (Fischer-Kowalski & Weisz., 1999; Fischer-Kowalski & Haberl 1998). Stocks are extremely material intensive and are key elements in understanding the society-nature interface (Baynes and Muller, 2016). Material flows are essential to stock; as the biophysical flows enter the system, they either remain as stocks or leave the system as seen in Figure 3 (Baynes and Muller, 2016). The material flows, alternatively referred to as “socio-metabolic flows” within the literature, maintains and shapes the biophysical structures referred to as material stocks, in the socio-economic sphere (Haberl et al., 2019).

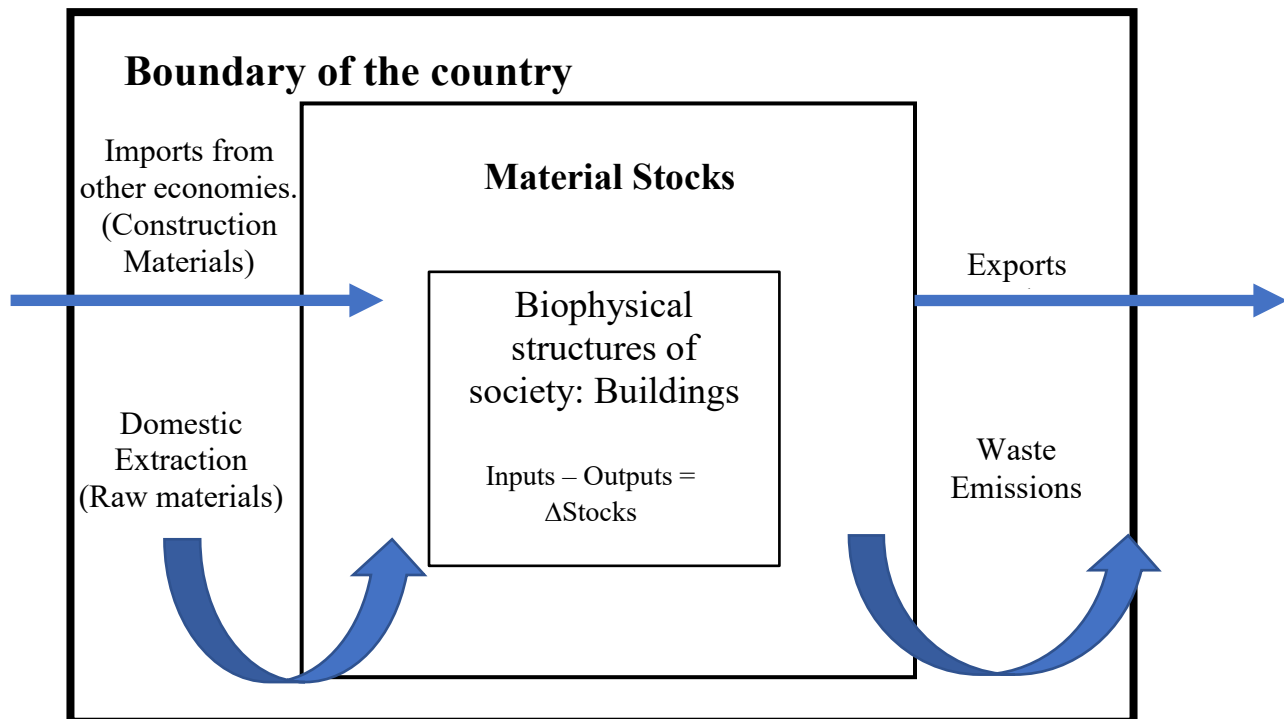

Figure 3: Stock-flow relations in socioeconomic metabolism modified and adopted from Haberl et al., 2017.

The role of in-use stocks, such as machinery, buildings and infrastructure are precursors for providing social systems with physical services catering to their basic needs (including mobility, transport, shelter, health) (Fishman, Schandl, Tanikawa, Walker & Krausmann., 2014).

The interrelationship between stock, flows and services is a new approach referred to as the material stock-flow-service nexus, which is an underdeveloped concept within socioeconomic metabolism research (Haberl et al., 2017). Through the stock-flow-service nexus, the resource flow of services and waste outputs are not independently determined by the stocks, but by the need of services provided by the stocks. The interrelationship between the material stock-flow service approach plays an instrumental role in climate related issues stemming from current environmental burdens. Climate change mitigation focuses on decoupling energy and material throughput from providing services to the social systems through transforming the material stock (Pauliuk & Muller., 2014).

The increases in stocks define parameters for industrial activity over time, and account for emission losses as well as “lifestyle lock-ins” (Baynes and Muller, 2016). For example, if developing nations are to achieve the same level of development as current developed nations, substantial infrastructure investment will be required, and therefore greater energy and material flows are needed to meet the demand of services required by the transitioning developing states. The role of stocks and flows can change over different time periods, either through short-term or long-term extents. Short-term changes in these stocks and flows are influenced by economic factors such as GDP, the economic markets or even a natural phenomenon such as extreme weather events. Long-term changes in stocks are a consequence of infrastructure requirement due to population change and economic activity (Baynes & Muller., 2016). Through the use of EW-MFA it provides knowledge of how an economy’s resource use can differ in response to short term and long-term changes.

2.3 Circular Economy: Closing the Loop

The previous sections explored the interrelationships between resource inflows and stocks or simply put the resource flows accumulated within the socio-economic systems. This subsection will discuss the outflows from the system in the form of waste generation through the lens of a circular economy. Circular economy (CE) is a term first emerging in China in 1998 as a new developmental initiative to combat economic growth at the cost of environmental degradation (Yuan, Bi, & Moriguichi., 2006). CE is a transformative pathway to economic growth that aligns

with the principles of sustainable environmental and economic development (Korhonen, Honkaslo, & Seppala., 2018). Geissdoerfer, Savaget, Bocken and Hultink (2017), defines CE “as a regenerative system in which resource input, waste emission, and energy leakage are minimized by slowing, closing, and narrowing material and energy loops. This can be achieved through long-lasting design, maintenance, repair, reuse, remanufacturing, refurbishing, and recycling” (p.759). Research surrounding CE has expanded, covering a wide range of topics such as circular regeneration of physical infrastructure (Williams, 2019), electronic waste management (Isernia, Passaro, Quinto, & Thomas., 2019), healthcare supply chain (Dau, Scavarda, Scavarda, & Portugal., 2019), and promoting resource efficiency with a low carbon development perspective in developing countries (UNDEP, 2016). CE weighs heavily on maximizing the waste outputs of resource use within socio-economic sub-systems, through transforming production and consumption systems (Camcho-Otero, Boks, & Pettersen., 2018). Outputs from one sub-systems are to be reused and recycled as inputs into other sub-systems, or within the economy as a secondary resource pool. Operationalizing CE will lessen the dependency on extracting virgin natural resources and the environmental degradation associated with these actions.

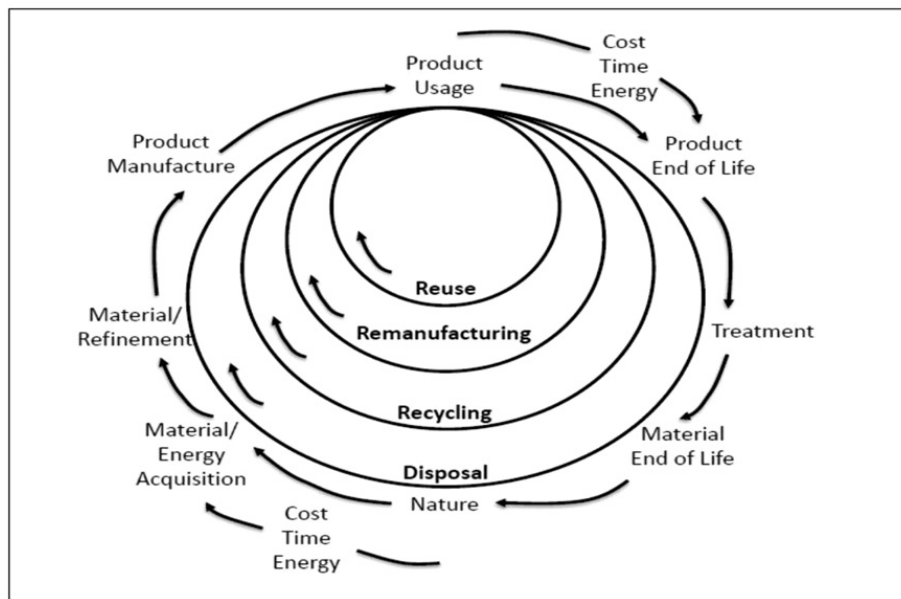

Figure 4: The conceptual framework of a circular economy (Korhonen et al. 2018).

Transitioning from linear unsustainable physical flows to closed looped systems minimizes the environmental burdens of extracting raw materials that are threatened by resource scarcity, whilst promoting sustainable development. Figure 4 depicts the main principle of CE, as material

resources are acquired, refined and manufactured into products, these processes requires greater amount of energy and materials. Transitioning towards the inner circle, the three key processes of recycling, remanufacturing, and reuse require less energy and materials. Figure 3 clearly outlines that disposal methods achieved through combustion and landfills are the least favourable options that should be avoided when necessary. Korhonen et al. (2018) explains that CE promotes greater value in resources, through spending more time in the inner circles for optimizing greater material efficiency within the socioeconomic system. Mayer et al. (2019) built a framework expanding on economy-wide material flow accounting to incorporate new indicators in measuring the scale and circularity of material and waste flows. This can be a useful in assessing waste flows on an economy-wide scale and determining the level of sustainable resource and materials use on multiple spatio-temporal scales.

Closed Loop systems and Construction

In order to maximize the lifetime of the building stock, it requires a substantial use of resource materials for two main purposes, such as adding to pre-existing building stock within the economy and for maintaining the current building stock. Based on the size of the building stock, the construction industry's use of resources impacts the environment through the continuous domestic extraction and inefficient use of materials from construction and demolition waste (CDW) (Condeixa, Haddad, & Boer., 2017). These issues, beckons for greater CDW management practices and sustainable use of raw materials. At this stage, CE can provide major contributions for adopting proper waste management techniques and develop effective policies within the construction industry. CE within the building and construction sector can alter production and consumption pathways, through promoting more sustainable avenues (Leising, Quist, and Bocken., 2017). Thereby, providing greater opportunity to decrease the use of primary materials, whilst safeguarding natural resource use and reduce anthropogenic carbon emissions (Adams, Osmani, Thrope, & Thronback., 2017). The construction sector generates large quantities of waste in response to the growing building stock, where in Samothraki C&D waste increased 15-fold from 0.5 kt/yr in 1971 to 7.6 kt/yr in 2016 within a 30-year time period (Noll et al., 2019). As a result of such rapid growth, the capacity for fostering greater environmental measures within the construction industry and its waste management is necessary in order to meet the resource needs of the present and safeguard the needs of future generations. Leising et al. (2018) suggests that the application of CE in material production and consumption is not exclusively dependent on

transforming linear systems to closed loop systems where waste serves as an input, but to ensure that material remains in-use within the material cycle by extending the product usage and life cycle for as long as possible, before entering the end stage of life i.e. extending the life cycle of the material to its maximum potential as depicted in Figure 4.

In the literature there is limited research on the application of circular economy initiatives and guiding principles in the built environment, with CE arising as a fairly new concept in its beginning stages (Leising et al., 2018; Pomponi & Moncaster, 2017). In current research, Noll et al. (2019) carried out a research study centered on Samothraki, Greece using a systematic and dynamic analysis approach to quantify the expansion of the built stock and the C&D waste generated as a result of the stock expansion. The C&D waste data was measured to create policy tailored towards sustainable waste management options focused on reducing, reusing, and recycling waste on the island.

Apart from implementing greater waste management policies, there is a widespread discussion on the drivers and advantages of CE, but little research on its application within the scope of construction and the building sector. Adams et al, (2018) studied the level of awareness of CE within the construction sector and the findings determined on the individual scale, their survey respondents had a basic understanding of CE concept. However, at the industry level there was a lack of awareness and general conceptualization of how CE in the built environment is supposed to function. Other factors such as the lack of market mechanisms and incentives were identified as factors preventing the transition towards a CE. Leising et al., (2018) discussed that in order to understand and adopt a framework for circular buildings, it requires a new design process in the supply chain, as well as extending responsibilities to actors along the building supply chain from start to finish. Pomponi and Moncaster (2017) discussed that research based on buildings from a CE standpoint should acknowledge the service life phase of a building, which extends over long periods of time with changing service use. Buildings are created by many manufactured components which are combined to produce a “complex”, dynamic entity.

2.4 Research in Material Flow Analysis used to Estimate Material Stocks

Two analytical methods used for measuring material stocks within material flow analysis research, include either a bottom-up or top-down approach (Muller et al., 2014). Bottom-up approaches are based on the separation of stock into individual use-type categories (shelter, commercial, etc.), and the application of material intensities (MI) to estimate the material stock

(Augiseau & Barles., 2017). Tanikawa et al. (2015) defines bottom-up accounts as “snapshots” of the material stock at a specific point in time known as static accounts (Muller et al., 2014; Augiseau & Barles., 2017). In addition to static accounts, MFA can be described as dynamic. Dynamic MFA are observed over a time interval or time series; a widely adopted method used in research focused on past, present, and future stocks and flows (Muller et al., 2014). The top-down approach on the other hand uses the net addition to stocks over a time series to estimate in-use stock values (Tanikawa et al., 2015). This approach derives the stock from the net flow amount, using inflow statistics expressed as the difference between what is consumed (inflows) and what is discarded (outflows), as well as the use of economy-wide indicators (input, output, consumption, productivity, balance) (Muller et al., 2014; Codeixa, Haddad, & Boer., 2017). However, in research focused on stocks and flows, a combination of approaches is utilized where the methodological framework and analysis can vary from one study to another depending on data availability, data requirements, and the research scope (Augiseau & Barles., 2017). Although there is a general consensus on the different methodological categories, the predominant use of hybrid approaches in studies blur the lines on distinctly defining each method (Wiedenhofer, Fishman, Lauk, Haas, & Krausmann., 2019). Wiedenhofer and colleagues (2019), identified the Material Inputs Stocks and Outputs (MISO)-model as a novel distinction between stock-driven and inflow-driven approaches by conceptually expanding the EW-MFA framework.

2.5 Top Down Approaches

Top-down and dynamic approaches have been dominantly used in material flow analysis research, to quantify material stocks, where most of the literature pertaining to material stocks have focused on metal consumption within the construction industry of different countries worldwide (Codeixa et al., 2017; Wiedenhofer , Steinberger, Eisenmenger & Haas., 2015). Daigo and colleagues., (2007) presented a study focused on estimating steel stocks in Japan. In this study the overall steel stock was separated into two distinct stock sub-categories, “in-use” or “obsolete stocks”. Through the use of dynamic modelling, the net addition to stocks were calculated annually. Data availability on material in-flows into a boundary are easily accessible and found in consumption or production sources, but the outflows are not formally recorded and rarely measured (Muller et al., 2014).

Alternatively, outflows are calculated from discard rates or lifetime distribution functions of the specific end use type categories and products (Moynihan & Allwood., 2012; Muller et al.,

2014). As seen in studies from Muller, Wang, and Duval (2011), Diaigo et al. (2007), and Hirato et al. (2009), the residence time model or Population Balance Model (PBM) were adopted for Canada, U.K, France, Australia, the US, Japan and other countries across the world to calculate material flows. PBM estimates the quantity of discards and stocks influenced by the domestic demands, from the start of the period being studied and accounting for the lifetime distribution of the individual end-use categories (Hirato et al., 2009). The lifetime distribution regularly adopted in studies are the normal distribution and Weibull distribution, which reflects the average lifetime span. Beta, and Gamma, and log-normal distribution are amongst the other types of distributions used by studies with a top down approach for estimating material stock and showing the historical changes of material stocks at a country-level (Muller et al., 2014).

Historical data plays an integral role within top-down approaches. Fishman et al. (2014) applied a top-down approach based on historical flow data for two national economies Japan and the United States. The total material stock was calculated by the economy wide material flow indicator, DMC (domestic material consumption) and the respective stocking rates for each construction material category which included (timber, non-metallic minerals, iron and other metals). On the other hand, in the absence of complete data on end-use and product lifetimes, Pauliuk et al. (2013), comprehensively analyzed the scope of the top-down methodology through three alternate approaches. They included: (a) the apparent outflow consumption of old scrap metal, (b) the lifetime model following a normal lifetime distribution, and (c) sector specific loss rates and a normal lifetime distribution, with the standard deviation and means linked to inflows and outflows. Results showed that stock estimates from the mass balance centered top-down approach in (a) were similar to those from (b) and (c), where results were optimized through sector and lifetimes splits.

Top-down accounts produce credible results in the absence of the time consuming and costly effects observed within bottom-up approaches (Fishman et al., 2014). In Tanikawa et al, (2015) analysis of 25 prominent construction material stock related studies to SEM, it was clear that the top-down approach was the more widespread research method adopted. Muller et al., (2014) found similar results in a comprehensive review of 60 dynamic analysis studies, where approximately 90% of the studies adopted a top-down approach and 10% adopted a bottom-up approach.

2.5.1 *Bottom-up Approaches*

Bottom-up approaches have been used to calculate construction material flows and stocks. Input parameters such as the floor area, growth of buildings, average number of persons per dwelling, average size of a dwelling area, have been used in studies to calculate the total dwelling stock of specific regions across the world (Sartori, Bergsdal, Muller, & Brattebo., 2008; Bergsdal, Bohne, & Brattebo., 2007). These input parameters as previously mentioned are referred to as socio-economic and population indicators. The use of these subset indicators in addition to the lifetime of dwelling units and renovations rates, are used as a whole to complete the analysis in modeling stocks and flows associated with construction and demolition activities and renovations in countries such as Norway (Sartori et al., 2008; Bergsdal et al., 2007).

This type of research is viewed as necessary tool for resource management, as changes in stock are indicative of primary resource consumption, as the outflow of demolition waste maximizes the potential to be used as a secondary resource depository (Muller et al., 2006). Shifting focus into maximize waste outflows, set the construction industry on a sustainable pathway with re-using or downcycling construction materials (Gonita et al., 2018).

The bottom-up approach requires end-use materials to be separated into different categories or typologies. Based on the material specific-typology, material intensities are distinguished to represent the material composition in order to calculate the material stock. The material intensity equals the amount of materials in each unit of use. For example, the amount of aggregates per meter square of a dwelling unit), as a means to calculating the material stock for each end use category. A similar methodology was adopted for residential buildings and the transport infrastructure within the European Union using a dynamic bottom-up approach, where the material intensities were defined by their main construction material categories including concrete, asphalt and other construction minerals expressed as weight per meter square (m^2) (Wiedenhofer et al. 2015). Further, Singh, Grunbuhel, Schandl & Schulz., 2001 adopted a comparable methodology to determine the material intensities for different built structure types on Trinket Island, India for estimating stocks.

Other studies have utilized the bottom-up approach to calculate the lost material stock in buildings and roads post disaster (Tanikawa et al. 2014; Symmes at al. 2019). Tanikawa., et al (2014) estimated the total loss of construction material stock in buildings and roads after an earthquake and tsunami impacted Japan. Material intensities (kg/m^2), and the total floor area (m^2)

of roads and buildings were indicating parameters used in calculating the total loss of material stocks in buildings and roads. The worse affected areas were identified through the use of geographical information systems (GIS), which facilitated in the creation of a sub database of roads and buildings to overlay with the tsunami impacted areas in order to estimate the total material stock lost.

The limitations of a bottom-up approach include restricting the study to small areas as a result of the time constraints and the copious amounts of data and data collection required in addition to the focus on a limited span of material categories within the literature, mainly pertaining to specific construction materials such as non-metallic minerals or steel material use (Moynihan et al., 2012; Condexia et al, 2017; Fishman et al., 2015).

2.6 Research adopting a GIS-based material flow analysis and alternative approaches.

GIS has gained a prominent role within material stock research, due to the interdisciplinary nature of this research area (Kohler, Steadman, & Hassler., 2010). GIS comprises of technology tailored on collecting, analysing, and managing georeferenced data to produce location specific information (Zhu., 2014). Heeren and colleagues (2018) presented a bottom up approach stock model which incorporates geo-referenced building data used to determine the building material stock of Swiss residential buildings based on volumetric properties. Similarly, Wallsten, Magnusson, Andersson and Krook (2015) combined a bottom up MFA approach with GIS, as an assessment tool to spatially characterize and examine hibernating metal stocks in the urban infrastructure. This methodological approach not only focuses on estimating the size of the metal stock, but also examines the spatial requirements needed to extract the metal stocks. In other words, focusing on the fundamental basis needed to achieve resource recovery.

Combining the use of spatial analysis and material flow analysis, enables the “spatio-temporal” patterns of stocks and flows within socioeconomic systems to be quantified which facilitates in a greater comprehension and management of metabolism (Liu, Chen, Lin, & Gao., 2019). Adopting a GIS based approach can be used to quantify spatial distributions of key construction materials (kg/m^2) as seen in a study from Mesta et al. (2018) which focused on estimating residential material stocks in Chiclayo City, Peru. The combined GIS and bottom up methodology modeled by Mesta et al. (2018) was very similar to that utilized by Symmes et al. (2019). The two studies establish building typologies for their study area and analyzed the physical

properties of the buildings to calculate the gross floor area. Material intensities were determined for each building type and material category, to map the spatial distribution of the material stock through a GIS model.

The application of GIS is not only limited to calculating the size of the material stock within a region, but from a spatial perspective it can identify where material stocks have accumulated and how they are distributed within socio-economic systems, as well as providing the necessary information to address efficient resource management. Kleemann et al. (2017) utilized GIS data to quantify material stocks in buildings and map their spatial distribution within the city of Vienna. Through the use of the GIS integrated methodology data pertaining to the building structure, material intensities, and demolition activities were combined and quantified to yield waste flow data. This information is centered around efficient resource-use management, and potential resources available for reuse and recycling thus possibly forecasting waste flows. This demonstrates the ability of GIS-based material flow analysis to assisting as a tool used within disaster management in quantifying the amount debris that can be potentially be produced at a building level post disaster in extremely threatened areas.

The applications of GIS and spatial data are numerous, as Tanikawa and Hashimoto (2009), focused their study on understanding the accumulation of material stocks on both a temporal and spatial scale in urban areas in Manchester, UK (8km²) and Wakayama city centre, Japan (11km²). The material stock estimates for roadways, buildings and railway were calculated through the use of four-dimensional GIS data as opposed to the two-dimensional GIS data sets as used in the previous studies. The four-dimensional data sets include surface and subsurface structures providing greater detail and greater analysis in material stock analysis. Tanikawa et al. (2015) argues that GIS is a critical component of material stock research within the socioeconomic metabolism framework. Through adopting a GIS-based MFA methodological approach, assessing the role of stocks within the socio-economic system is not primarily solely focused on quantifying and determining the quality of the material stock (Tanikawa et al., 2015), but also on the importance of spatial data and mapping the spatial distribution of the material stock to see where stocks are located .

In recent years spatial data has significantly contributed to material stocks and flows analysis research. Spatial analysis illustrates patterns and highlight problems that may not be visible if analysis was strictly represented through numbers, text, or graphs (ESRI., 2012). Lie et

al. 2019 proposed a framework combining spatial analysis and material stocks and flows analysis, where spatial analysis can assist in:

- Creating dynamic and spatial models
- Data visualization and management
- Examine spatio-temporal processes, drivers, and patterns.

Based on these three features spatial analysis can identify material accumulation hotspots and identify drivers of material stocks and flows, models can be used simulate the growth of stocks and flows and estimate potential waste outputs from material consumption. Limitations towards the adoption of spatial analysis includes the accuracy of material flow analysis with respect to hidden flows. Lie et al.2019 explained within a stock driven model estimating net flows of construction may appear to be simple. However, most times the material input and output flows are often underestimated due to the inconsideration of flows related to building repairs, maintenance and expansions. Overall, the contribution of spatial analysis and its coupled use within material stocks and flows analysis strengthens socio-metabolic research in achieving sustainability.

2.7 Sea Level Rise Methodological Approach

The occurrence of sea level rise coupled with extreme weather events forms a major threat to SIDS (UN-OHRLLS., 2015). It is estimated that 70% of the Caribbean population living within coastal regions highlighting the major threats posed by sea level rise within the island's socio-economic environment. Thereby, predicting the impact of global projected sea level rise becomes vital for future sustainable development.

A wide variety of methodological approaches have been adopted in previous sea level rise analysis. Alshali and Alhasem (2016) estimated inundated areas on Kuwait coasts using ESRI ArcGIS and its spatial tools. The methodological approach included the use of the digital elevation model (DEM) to produce a raster layer, where the pixel levels below and above the projected sea level rise estimates were represented by values 0 or 1. A cost distance of each pixel in the raster layer in reference to the seawater was examined to evaluate the pixel's connectivity to the seawater, to identify as inundated areas and barriers between low-lying lands. Afterwards, all areas with pixels equalling to 0 were totalled and identified as inundated areas, based on tidal range and geographic location. Poulter and Halpin., (2005) emphasized on the role of the DEM (the spatial distribution) and the connectivity rule plays in a sea rise

analysis. Three raster modeling approaches were examined to assess the threat of coastal flooding arising from sea level rise using lidar DEM. The first approach adopted the “zero-side rule” which indicated that a grid cell was inundated if the elevation level was less than the sea level rise projection. The limitation to this approach is the lack of consideration for surface connectivity between the land (grid cells) and shore. The second (four side rule) and third (eight side rule) approaches were similar to the first but considered that the grid cell is inundated if it is below the sea level rise projections as well as if the connected grid cells are exposed (inundated) or if it was in open waters. The four-side rule (underestimates the surface flow connections) and eight-side rule (overestimates the surface flow connection) are referenced with respect to the ability to accurately resolve the surface flow connections (Poulter & Halpin., 2005). Gesch., (2009) identified inundated areas through the grid pixels on the raster elevation layer that below the elevation level of the sea level rise analysis and hydrologically connected to the ocean. Lichter and Felsenstein (2012) in assessing the cost of sea level rise at a local scale with a contour layer was converted to into a raster DEM to distinguish between land and sea. The ArcGIS “Topo to Raster” tool was used to create a hydrologically accurate DEM followed by the use of a vector layer of the shoreline to identify inundated areas at specific elevation levels.

2.8 Material Stock Research Findings

In the socioeconomic environment, construction materials function as the largest group of materials that are stocked in terms of mass and remains in-use for extended periods of time (Tanikawa et al., 2015). In the 20th century (approximately from 1900-2010), the global material stock experienced a 23-fold increase from an estimated 35 Gt to 792 Gt in 2010 (Krausmann et al., 2017). Consequently, from this enormous growth in stocks, resulted in the unequal distribution of material standards of living recognized as a serious problem prompting for immediate action to facilitate in a sustainably driven society (UNEP., 2016). National accounts of regions such as Europe and North America reported a per capita material footprint value between 20 to 25 t/cap. In contrast, the per-capita material footprints in the Caribbean, Latin America, Asia-Pacific and other regions around the world measured between 9 t/cap to 10 t/cap; roughly half the amount of their highly developed counterparts (UNEP., 2016). The disproportionate rates and large gaps in the material standards across these regions speaks to the wide variation in the level of material

consumption within the different regions and where materials stocks are accumulating at higher rates as a result of the socio-economic system's interactions with the natural environment.

Krausmann et al. (2017) reported comparable findings in 2010, where there was a large difference between the average amount of material stocks within high income industrial countries in comparison to developing countries. In developing countries, the average material stocks totalled to 38 t /cap, while the material stock of industrialized countries amounted to a sum nine times greater, measuring at 335 t /cap. This disparity observed in material stocks and material footprints on a global scale, widens the gap between the standards of living. However, material stock flow relations provide a platform to expand knowledge on resource use patterns (Krausmann et al., 2017) with the goal of closing the loop in the resource-use, material cycle to achieve widespread sustainable development.

In the island of Japan from 1945-2010, the highest concentration of material stock was situated in buildings, followed by roads, where the two main materials were cement concrete and asphalt (Tanikawa et al., 2015). Similarly, in the USA from 1930-2005, the growth of material stocks increased from 11 billion tonnes in 1930 to 107.5 billion tonnes in 2010. The growth in material stock was driven primarily by the non-metallic mineral components within buildings and the infrastructure, such cement, sand, and gravel. Further highlighting the role and importance of non-metallic minerals in the construction, as they are the fastest growing group of materials in the sector (Fishman et al., 2014; Schandl et al., 2018).

In "The Weight of the Nations" second report Mathews et al. (2000), the NAS (net addition to stock) for five countries (Austria, Netherlands, Japan, Germany, USA) were distinguished by their mature industrialized economies. In spite of their established physical infrastructure, these countries demonstrated a continuous growth in the amount of new construction materials required yearly, with little to no signs of material reduction (Mathews et al., 2008). In response to the growth of material stock and accumulation from 1900-2010, the 20th century also experienced an increase in outflows due to aging buildings and other "in-use" material stocks (Krausmann et al., 2018). Outflows increased from 0.8 Gt/yr to 14.5 Gt/yr in 2010, where 50% of the outflow was classified as concrete drawing on the importance of CE within the construction industry.

The growth of material stocks has been driven by the building stock, and physical infrastructure. Buildings are constructed for the purpose of catering to human demands (Ceng, Hsu, Li, & Ma., 2018). The distribution of material stock is based on its respective end-use

categories which are studied from different local scales, with the focal point of the research being centered around residential and non-residential buildings (Muller., 2005; Kleeman et al.,2016; Cheng et al., 2018) Material stock research emphasizes on the role of the end-use type categories and the services they provide in analyzing and understanding resource use patterns on different temporal scales.

In assessing material stocks, the literature is limited to specific groups of material and geographical focus points, where material stock research appears to be more centered on more developed and industrialized countries as opposed to smaller developing states and islands which are exposed to greater risk threatening their material stocks. On smaller scales, there has been extensive focus on the dynamics of the building's stock accumulation within cities, with the use of per capita rates as a useful indicator in understanding material accumulation on different spatial scales. In a local study on the city of Taipei, the total building stock was estimated to 183.4 Mt (Cheng et al., 2018). The city has a population of 2.7 million people, equals to 68 t/cap. For the city of Vienna, the estimated building stock amounts to 380 Mt, which equals to 210 t/cap (Kruasmann et al., 2017). Vienna has a population of approximately 1 million less people than Taipei, but the material stock per capita rate is five times higher than Taipei.

The differences between the total material stock of these two cities can be an indicator of varying levels of economic and social conditions such as material living standards, lifestyles and industrial growth between the two cities. Another study on the material stocks on Trinket Island measured building stock at 9.1 t/cap indicates how changes in construction materials from traditional (wood and grass) to non-traditional materials (cement, sand, gravel, steel) can be used to capture the effect of external markets and consumerism had on a traditional values of an indigenous society (Singh et al., 2001). In 2004 after the Nicobar Islands experienced a tsunami unleashing an unmeasurable amount of damage on the islands, developmental aid transformed their traditional way of living to new high consumption lifestyle. As result domestic material consumption rate pre-tsunami measured at 3.7 t/cap increased six-fold to 34 t/cap post-tsunami (Singh & Haas., 2016). Thus, showing the rule of material flow stock accounts in capturing socio-economic changes within traditional communities to global material influences.

2.9 Island vulnerability: The link between climate and socioeconomic vulnerability.

SIDS are heavily impacted by heavy rains, hurricanes, storm surges, ocean acidification, and sea level rise. The severity of these natural disasters is exacerbated by climate change (WMO., 2016). The vulnerability of SIDS varies extensively, taking into consideration that similar hazards experienced by individual islands can result in different magnitudes of outcome and physical damage (Sjostedt & Povitkina., 2016). Some countries may witness an unmeasurable amount of destruction, while other countries only experience minimal damage. Thus, showing the extent to which vulnerability can span from country to country; where vulnerability is viewed as the “predisposition to be adversely affected” (IPCC., 2012).

The Caribbean is the second most hazard prone region in the world where natural disasters specific to the archipelago include floods, volcanic eruptions, landslides, and hurricanes. For small island states within the Caribbean, climate change has the potential to increase the chances of storm surges, loss of land and property, and the dislocation of communities, which stems from the overall increase in the uncertainty of weather hazards (Tompkins., 2005). Geographical vulnerabilities are a contributing factor to the threat posed by climate change for these islands. In the Caribbean region these islands are situated within the hurricane belt and also are centered in one of the main six tropical areas where hurricanes develop on a yearly basis, thus increasing their overall susceptibility to storms (CEP., 2001; UNDESA., 2014). Alongside the concern for storms, the impacts of sea level rise and storm surges amongst the Caribbean and the CARICOM states introduces both short-term and long-term major threats. Global sea level rise is projected to range between 1-2 m above present levels at the end of the 21st century. The impact of the projected sea level rise within the Caribbean will be uniform, where countries like The Bahamas and Trinidad & Tobago will face the largest sum of damages and losses (Simpson et al. 2010). In comparison to smaller countries where the magnitude of economic loss in comparison to the size of the economy will be greater felt in islands such as St Kitts & Nevis, Grenada, Antigua & Barbuda and alongside remaining SIDS.

2.9.1 *Extreme Weather Events: Historical trends of storms*

Storms report the highest economic losses per climate related disaster than any other type of disaster measured at 55% (CRED., 2018). From 1979 to 2017, 9 noteworthy hurricanes passed through the Caribbean including: David (1979), Gilbert (1988), Hugo (1989), Luis (1995), George (1998), Hurricane Jose and Tropical Storm Lenny (1999), Hurricane Omar (2008), Hurricane Earl

(2010), and Hurricane Irma (2017). Throughout this 38-year time period some islands were repeatedly impacted by more than one hurricane above mentioned hurricanes. A total of 7 of the 9 hurricanes were classified either as a category 4 or 5 hurricane. The high intensity of the hurricanes was reflective of the high price tag accompanied by these hurricanes. The cost of damage and lost inflicted by these hurricanes ranged between 40% to 797% island’s GDP (Gibbs., 2001; CRED., 2018). During the 2017 Atlantic Hurricane Season Dominica was exposed to losses amounting to 259% of the country’s GDP due to the destruction of hurricane Maria and Sint Maarten incurring cost of 797% of their GDP as a result of hurricane Irma (CRED., 2018). Post hurricane housing damage and loss of infrastructure were the two main areas of concerns that suffered great damage.

Antigua & Barbuda, has experienced severe category 5 hurricanes in the past, causing widespread damage. The financial cost of hurricanes over the past 12 years since 2017, have resulted in 950 million USD in Antigua & Barbuda, where the twin island country has experienced approximately 128 storms and hurricanes from 1851 to 2017 (GCF., 2017; Antigua & Barbuda Meteorological Services., 2018). Table 1 summarizes the major storms passing through the twin island state and their estimated cost of damages.

Table 1: Major Hurricane Storms and their Cost of Damages experienced by Antigua & Barbuda and the wider Caribbean Region

Name and Date of the Hurricane	Category of Hurricanes	Estimated Cost of Loss & Damages	Countries/Areas Impacted
David 1979	5	1.54 million USD	Puerto Rico, Cuba and more
Gilbert 1988	5	Total cost damages were 2.9 billion USD	Jamaica, Haiti, Lesser Antilles and more
Hugo 1989	5	Total cost of damage 2.9 billion USD	After Hugo’s passing 509 were left homeless in Antigua & Barbuda. Other countries impacted include Puerto Rico, Dominica, British Virgin Island, US Virgin Islands and more.
Luis 1995	5	Total estimated cost of damages was 3 billion USD	Major damages experienced in Antigua & Barbuda. Other countries such as St Maarten Guadeloupe, Dominica, and St Martin.
George 1998	4	Total cost of damage 6.4 billion USD	US, Puerto Rico, the US Virgin Islands, The Dominican Republic, Florida, Haiti, and Antigua.
Hurricane Jose & Tropical storm Lenny 1999	Jose- 2	Total cost of damage did not exceed 5 million USD	Antigua experienced minor damages with countries including St. Maarten, Puerto Rico and the U.S. Virgin Islands were impacted by Jose. Lenny impacted Grenada, St. Vincent and the Grenadines, and Montserrat.

Hurricane Omar 2008	4	Estimated damage at 16.3 million USD in Antigua & Barbuda	Omar impacted the Leeward islands, with Antigua & Barbuda experiencing flooding caused from storm surges with buildings in low-lying areas greatly impacted.
Hurricane Earl 2010	2	Damages in Antigua & Barbuda were estimated at 12.5 million USD	In the northern Leeward Islands homes and buildings were damaged due to inland flooding caused by storm surges and high wave levels in low-lying areas.
Hurricane Irma 2017	5	Property damages ranging between 150 and 300 million USD in Barbuda	The sister isle of Barbuda was directly hit by hurricane Irma. Inundation levels of 8 ft (2.4m) above ground level were on parts of Barbuda. Irma caused 47 direct deaths with most of the casualties recorded in the Caribbean region, where Irma's winds were felt the strongest. Other islands impacted were Saint Martin and Saint Barthelemy, Cuba, Sint Maarten, the British Virgin Islands, the U.S. Virgin Islands and the US.

Hurricane Data Sourced from NODS and the National Hurricane Center.

In 1995, Antigua & Barbuda was one of the countries greatly impacted by category 5 Hurricane Luis which wreaked havoc and harm on the twin island state, it is described as one of the most severe hurricanes ever recorded. Hurricane Luis destroyed hotels situated on the coast of the island which resulted in a 17 % decline in tourist arrivals during 1995 (GCF., 2017). The severity of damage on the island was attributed to “unsound” structural design (including weak structural attachments of roofing materials), inadequate maintenance buildings, and buildings not adhering to the building code, all of which amounted to an estimated \$US 461 million worth of damages (Gibbs & Alphen., 1996; NODS., 2019). On the sister isle of Barbuda, the damage to physical structures was estimated at 70% accompanied by the physical damage caused by severe erosion and flooding (Lawrence, Mayfield, Avila, Pasch & Rappaport., 1997). These factors also contribute to the vulnerability of the island on a whole in response to extreme weather events.

In 2017, Antigua & Barbuda experienced another category 5 hurricane called Irma which resulted in disproportionate destruction in Barbuda in comparison to Antigua with only minimal damage. Barbuda was in the direct path of the hurricane, thus causing total destruction due to the island’s low level of elevation, and with majority of Barbuda being only 3 meters above the sea level (GCF., 2017). This warranted immediate action for the Barbudans inhabitants to be evacuated

to the mainland Antigua. The aftermath consisted of high volumes of lost building stock which accounted for 90% of the total buildings in Barbuda, including the loss of essential services such as airports-transportation, hospitals-health, and schools-education.

To note, the majority of populations within SIDS reside in low elevation coastal zone areas (UN, 2010), where 26% of the land area is 5 meters below sea level, with approximately 19.5 million people living within this low coastal region within the SIDS. Thus, climate hazards and extreme weather events poses high risk to an islands socio-ecological system. Climate change is expected to increase the frequency and severity of natural hazards, while increasing the threat level face by SIDS to these events (GCF., 2017). Thus, cautioning for greater resiliency and climate action on vulnerable SIDS, like Antigua & Barbuda.

2.9.2 Climate Vulnerability and its influence on the socio-economic systems within the island context

The unprecedented negative impacts of climate change for these small island states calls for adaption and mitigation strategies to be implemented throughout the region. The adverse impacts of extreme weather events are not only restricted to the environmental losses, but to the socio-economic systems within the islands. Benjamin (2010) suggests that climate change should be redefined from an environmental perspective to include the associated developmental and economic implications it has for vulnerable developing countries such as SIDS within the Caribbean. The economies in SIDS are characteristically small, lack diversification, heavily rely on external supply and demand flows, (IPCC., 2010; WMO., 2016). Therefore, the economies of SIDS are extremely vulnerable to external shocks. Statistics show that 70% of economic activity in SIDS is within the shoreline, (CDEMA., 2014). Therefore, events including coastal erosion, storm surges, torrential rain, flooding, and sea level rise can easily dismantle the physical infrastructure supplying essential socio-economic services. For most SIDS, especially in the Caribbean the main economic activity or industry is built upon the country's natural environmental assets such as fisheries, agriculture, and tourism, all of which are categorized as climate vulnerable activities (Mycoo., 2018).

The tourism industry is prevalent amongst most Caribbean SIDS and is a key driver to economic growth. However, as storms and hurricanes become more severe, the now thriving tourism industry will undergo a decline in the traffic of tourists visiting from other countries and an increase in the physical damages of resorts and hotels. Beach erosion is another area of concern

with estimated retreat rates of 0.16 meters per year for the Atlantic and Caribbean coasts, thus hindering the prominent sun, sea, and sand tourism capitalized amongst most islands (ECLAC, 2019). One current problem annually impacting the Caribbean region's shoreline is the accumulation of sargassum seaweed. In 2018, the estimated beach clean-up cost of sargassum on the region's beaches amounted to US\$ 120 million (King., 2018). The presence of the seaweed stains the beautiful images of white sandy beaches and clear blue waters. Consequently, deterring tourists from visiting the island as a result of the lack of access or a decrease in usability to beach front properties. Vast amounts of seaweed dominating the shores creates an unwelcoming view for visitor who may be tainted from revisiting the island in the future. All at a cost of "reputational damage" which warrants major concerns for the island tourism industry (King., 2018). As a result of the high amount of seaweed deposited on the shore, it starts to decay and releases an unpleasant smell causing an environmental nuisance that deter both locals and visitors from the beaches. The cause of the sargassum invasion is linked to multiple factors including both anthropogenic and natural causes including a change in the ocean's chemistry and climate change (Briggs., 2019; King., 2018) Phenomena such as the sargassum bloom and other related climate events directly threatens services vital to SIDS' economies. Consequently, causing a reduction of public tax revenues and private income that are directed to social services, education levies, medical benefits, and infrastructure development (Bueno et al., 2008).

Disaster risk reduction frameworks should be implemented to cater to the economic, social and environmental viability of these vulnerable small islands states to adapt and mitigate against the heightened risk levels to these extreme weather events. Sustainable development goal (SDG) 13 framed by the UN focuses on enforcing immediate action to fight against climate change and its impacts. SDG 13 acknowledges coupled relationship between environmental and economic vulnerability SIDS faces as well external and structural challenges hindering the progress of sustainable development. In response the UN has implemented climate financing funds increasing access to monetary funds and partnership networks focused on building adaptive capacities to cope with the impacts of climate change. International funds such as the Green Climate Fund, help to secure climate finance for vulnerable countries like Antigua & Barbuda which has secured two

readiness grants¹. However, small island states have to first meet the “complex compliance procedures of international funds before gaining access to actual funding (Ali., 2018).

2.9.3 Island Sustainability: Industrial Ecology through the lens of Material Stock and Building Infrastructure Resiliency

Island systems offer a unique perspective in the way industrial ecology can be understood and applied in achieving sustainable development goals on a local scale due to an island’s socio-ecological system and distinct system boundaries (Deschenes and Chertow, 2004; Noll et al., 2019; Wallner & Narodslawsky.,1994). As a result of the unique characteristics of islands including their closed boundaries and sense of remoteness (geographic boundedness), they are viewed as controllable units of study, and model systems in tracking resource flows across their system boundaries (Noll et al., 2019; Deschenes and Chertow, 2004). As a result, islands aid in a greater understanding of the interaction between human activities (social systems) and the environment in overcoming challenges facing sustainability (Petridis & Fischer-Kowalski., 2016).

Industrial ecology tools have been applied to a growing area of study focused on island studies in analyzing their flows and stocks within a socio-metabolism framework. A few studies have included the application of a material flow analysis in Trinidad and Tobago and Iceland (Krausmann, Richter, & Eisenmenger., 2014), and the Philippines (Martinico et al., 2016). A material stock flow analysis carried out in Grenada on construction materials (Symmes et al., 2019), and a biomass material flow account in Jamaica (Okoli., 2016). Stocks and flows were studied in the Greek island of Samothraki using a socio-metabolic approach (Petridis & Fischer-Kowalski., 2016) and a material and energy flow account on Trinket Island (Singh et al., 2001). However, the role of material stocks in building infrastructure resiliency within the context of SIDS is an underdeveloped area of research within the field of industrial ecology that will be beneficial within the small island developing context.

¹ Antigua & Barbuda total amount of approved Green Climate Funding amounts to 20.0 million USD with 2.2 million USD disbursed for readiness (GCF., 2019).

3 Methodology

This chapter describes the methodology used to analyze the research objectives noted in Section 1.3. The thesis aims to quantify resource-use patterns of key construction materials in physical units through analyzing the flow of materials in and out of the country's system boundaries over a period of 11 years (2006-2017). An economy-wide material flow analysis methodology outlined in Section 3.1 was used to measure and track material inflows and outflows, domestic material consumption, gross additions to stock and net addition to stock. Section 3.4 examines the social and ecological performance of the island. Section 3.3 to 3.10, outlines the steps taken to quantify and map the spatial distribution of the material stock (MS) accumulated within the country through the use of GIS-related tools based on a bottom-up approach. Section 3.10 proceeds to outline the methodology used for assessing the vulnerability of the material stock through various sea level rise scenarios and identifying flood prone coastal areas. To facilitate the magnitude of analysis undertaken in the study, a database comprised of trade statistics, census statistics, housing data, hurricane data, spatial data, and waste receipts were compiled for Antigua & Barbuda (Table S6). The research was framed by the following parameters:

1. The study conducts an analysis of the in-use material stocks of buildings solely situated on the main island of Antigua. Datasets of building footprints were unavailable for the sister isle, Barbuda, as a result Barbuda could not be included into the material stock analysis (MSA). However, despite Barbuda consisting of approximately 3% of the Antigua & Barbuda's population, the sister island contains approximately 2% of the housing stock in addition to the access to essential services such as a hospital, banking related facilities, schools and hotels which would have had a slightly significant impact on the total material stock estimate for the island.
2. The EW- MFA (economy-wide material flow analysis) presented in this research focuses strictly on imports, domestic extractions and exports for both Antigua & Barbuda. In this study, indirect flows of imports and exports alongside unused domestic materials were not included. They are outside of the system's boundaries and cease to enter the focus system's economy; as a result; they do not become a part of the MS of the economy (Fishman et al, 2014).
3. Other construction styles: abode/clay structures and makeshift structures were identified as two additional construction styles in Antigua & Barbuda, accounting for less than 0.5% of

the materials used in the outer walls of household dwelling units (Statistics Division, 2001). As a result, these construction styles and their material components were not included in the research analysis, since their contribution were minimal compared to the use of the remaining construction styles. This pattern was also reflective on the ground, during field visits, where abode/clay structures were rarely identified on-site. Indicating that these materials do not play integral role in Antigua and Barbuda's economy.

Building footprints identified as ruins, abandoned buildings, and on-going construction were not included in the total material stock calculated for Antigua & Barbuda. The three categories of building use-type accounts for 8% of the country's building footprints in 2004. To assign these types of buildings a material intensity typology would be unrealistic and complex in nature without on-site inspections and field visits of these individual building footprints. Taking into consideration that some of these buildings would be in the process of on-going construction and abandoned buildings that have not completed construction, would not be classified as an "in-use material stock". However, the role of these buildings should not be dismissed, but evaluated in terms of inactive or idle building stocks. These categories of buildings have an instrumental role to play in sustainable management and resource efficient development.

3.1 Methodology for material flow analysis (MFA).

This section specifically focuses on the steps taken for an economy-wide material flow analysis (EW-MFA) of all construction materials flows entering and leaving the boundary of Antigua & Barbuda's economy on a national scale. The system boundary for this material flow analysis is the interface between socio-economic systems and the natural environment. This uniquely defines and identifies the focus system of the material flow account from other socio-economic systems (OECD, 2008b). The system boundary aligns with Eurostat (2001) guidelines, where a system can be described through the lens of flows and stocks, illustrated in Figure 5.

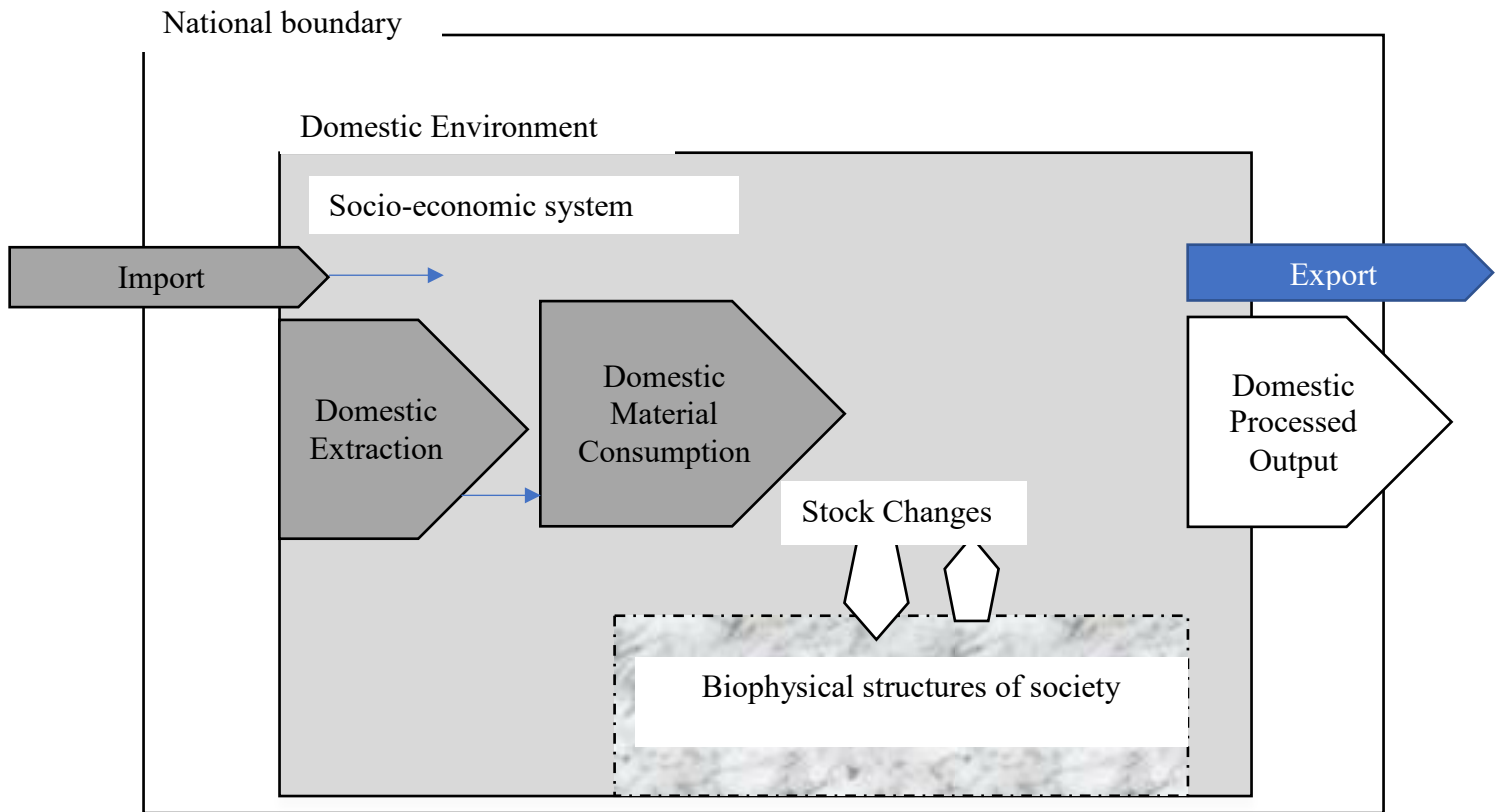

Figure 5: A schematic diagram of the economy-wide material flow accounting (EW-MFA) conceptual framework modified from Wiedenhofer et al. (2019).

In Figure 5, socio-economic material flows follow a mass balance scheme and can be tracked based on inputs in the socioeconomic system such as “Imports” which are defined based at the cross point where the outer national boundary enters the national economy and inputs from the natural environment are referred to as domestic extraction (DE). Domestic material consumption (DMC) identifies materials directly used within the economy and domestic processed output (DPO) represents materials flows entering the environment after being used in the economy such as waste in landfills. Exports are outflows from the national economy flowing across the national boundary.

3.1.1 Spatial and Temporal Scale

The temporal boundary for this research is defined by the time unit of a year, where stocked materials are specifically defined as materials that remain in the system for longer than a year. Stocks are materials that do not leave the system and are referenced to as a point in time (OECD, 2008b). Flows describe the exchange of energy and materials between and within activities or

systems (OECD, 2008b). Therefore, in this study EW-MFA provides a greater understanding of the material basis of the local economy (OECD, 2008) through a time series account of construction materials domestically extracted, imported, exported and added to the local economy through the accumulating building stock.

3.1.2 MFA Indicators for construction material flows

This section identifies the main MFA indicators included in this study. The MFA indicators can be categorized into clusters such as input, output, consumption, and balance indicators. These aggregated measures of material flows provide greater insight into the industrial metabolism within Antigua & Barbuda (Eurostat, 2001). GDP and per capita values were used to compare material flows to economic growth, and to compare MFA indicators within a cross country analysis through studying the average material standards. GDP and population values were sourced from the World Bank’s database. The MFA methodology adopted in this study is derived from a similar MFA methodology used by Symmes et al. (2019) for conducting a MFA on construction materials in another SIDS in the Caribbean, Grenada. Six out of the seven indicators used are derived from Eurostat (2013) and the remainder indicator is adopted from a MISO (Material Inputs, Stocks and Outputs) model by Krausmann et al., (2017). The six MFA indicators used for the time-series analysis from 2006-2017² are as follows:

Table 2: A summary of the MFA Indicators and their role in the MFA of Antigua & Barbuda.

MFA Indicators	Description
Physical Imports (Material Input Indicator)	The total number of imported construction material flowing into Antigua’s & Barbuda’s economy is representative of the amount of construction materials required for sustaining the country’s economic activities (OECD, 2008).
Physical Exports (Material Output Indicator)	Exports are representative of the outflow of construction materials leaving Antigua & Barbuda’s economy. This output indicator shows the flow of construction materials from the local economy based on production and consumption activities (OECD, 2008).

² The time series account for trade data between 2006 and 2017, did not include statistics from 2008. Trade statistics from 2008, could not be sourced from both local and international data sources. Therefore, the MFA could have included an analysis for trade statistics for Antigua and Barbuda 2008 could not have been included in the analysis due to the missing data.

Physical trade balance (PTB). Balance indicators	PTB indicates if an economy is in trade surplus or deficit in physical terms (Eurostat, 2001). PTB indicates the net physical trade flows of construction material added to Antigua & Barbuda's economy. The PTB of material m in year t is calculated as follows: $PTB_m(t) = Imports_m(t) - Exports_m(t)$
Domestic Extraction (DE). (Material Input Indicator)	DE measures the amount of raw materials taken from the country's environment used as inputs for the production of construction materials. In Antigua & Barbuda this mainly consisted of mineral based elements such as sand and gravel. The calculation for DE is specified in section 3.1.5
Domestic Material Consumption (DMC). Consumption Indicators	DMC accounts for the total amount of construction material directly used in the economy. The DMC of material m in year t is calculated as follows: $DMC_m(t) = Imports_m(t) + DE_m(t) - Exports_m(t)$ (Eurostat, 2001).
Gross Addition to Stock (GAS). Consumption Indicator	GAS measures the total amount of construction material added to the economy (material stock) yearly in Antigua & Barbuda. It accounts for processing and manufacturing loss rates presented by primary and secondary inputs to stocks. GAS of material m is calculated as follows: $GAS_m = DMC_m(t) \times (1 - \text{processing loss rate}_m) (1 - \text{Manufacturing loss rate}_m)$ (Krausmann et al., 2017)
Net Addition to Stock (NAS) Balance Indicators	NAS measures the growth of the economy in terms of the total amount of construction material added to the material stock (buildings) and are removed through and construction and demolition waste (removals). NAS of material m is calculated as follows: $NAS_m(t) = DMC_m(t) - Removals_m(t)$

3.1.3 Data sources

The EW-MFA of Antigua and Barbuda presented in this study consisted of a time series account using import, export, and domestic extraction data of construction materials from 2006 to 2017. The trade data pertaining to the imports and exports, were collected from the United Nations Comtrade Statistic Division and the local Statistics Division in Antigua & Barbuda. The EW-MFA methodology used in this research followed the methodological guidelines of Eurostat,

(2001). Eurostat follows a hierarchical classification system, where physical inputs are grouped into four main categories: biomass (MF.1), metal ores (MF.2), non-metallic minerals (MF.3) and fossil energy (MF.4). There are further categorized by material classes, groups, and sub-groups, representing a total of 50 material categories as shown in Table 3 (Eurostat, 2018).

Table 3: Eurostat classification of domestic materials, imports, and exports.

Main Category	Material Class/Group Code	Name of Material
Biomass -MF.1	MF. 1.3	Wood
Metal Ores -MF.2	MF 2.1	Iron ores and concentrates
	MF .2.2	Non-ferrous metal
	MF. 2.2.1	Copper
	MF.2.2.2	Nickel
	MF.2.2.7	Aluminium
	MF .2.2.3, 2.2.4, 2.2.5	Lead, zinc, and tin
Non-metallic minerals (MF.3)	M.F.3.1	Ornamental and Building Stone: Marble granite sandstone porphyry, basalt, building stone
	M.F. 3.2	Chalk and dolomite
	M.F.3.3	Slate
	M.F. 3.5	Salt
	M.F. 3.6	Limestone and gypsum
	M.F. 3.7	Clays and kaolin
	M.F. 3.8	Sand and gravel
	MF. 3.9	Other non-metallic minerals n.e.c

Source: Adopted from (Eurostat, 2018)

3.1.4 Trade Data

Trade data for Antigua & Barbuda consisted of imports and exports of construction materials collected under the three main categories of materials focused on in this study. They include non-metallic minerals, wood, iron and steel and other metals. A full list of the materials

quantified in the research study can be found in the appendix in Table S4. Trade data were sourced from two main sources including the National Statistics Division and the UN Comtrade. The local Statistics Division send their yearly trade data to the international organizations such as UN Comtrade that records all data and make it readily accessible to users. Each construction material is identified by their harmonized codes (HS) used in coding systems for assisting Customs in tracking and managing trade statistics on an international basis. They were data discrepancies such as extremely high quantities recorded for specific commodities such as HS 2523: Portland cement (portland, aluminous, slag or hydraulic). In 2012 the reported quantity for HS 2523 was 500 % greater than values reported in previous years. Through contacting the local Statistics Division in Antigua & Barbuda the correct quantity for 2012 was given and corrected. However, trade data for 2008 is still outstanding and could not be included in the material flow analysis. Data quality was a major issue and required a thorough data quality check and assessment for inconsistencies.

3.1.5 Domestic Extraction

Domestic extraction of construction materials in Antigua & Barbuda is limited to the production of sand and gravel. Sand and gravel are primarily used for concrete production in structural and civil engineering related projects, mainly the construction of buildings and roads (Eurostat, 2018a). National statistics on the domestic extraction of non-metallic minerals are the most underreported category of materials in many countries with the highest degree of uncertainty (Fischer-Kowalski et al., 2011; Miatto et al., 2016; UNEP., 2019) including in Antigua & Barbuda. In the presence of inadequate domestic extraction statistics, the estimates of sand and gravel were calculated based on the apparent cement consumption (ACC) and other material proxies used to estimate the sand and gravel domestic extraction. ACC represents the domestic material consumption of cement within the country see Table 2 for the indicator's equation and function. The sand and gravel input into concrete production can be calculated using the following equations:

1. *Sand and gravel input*_{concrete} [t] = DMC_{cement} [t] × λ_{concrete}

λ_{concrete} coefficient adopted in this study equals to 5.26 derived from Miatto et al., 2016. In the literature, the coefficient for concrete varies as Krausmann et al. (2009) reported the highest coefficient of 6.5 in comparison to Eurostat (2013) with a coefficient of 6.09, and Miatto et al. (2017) reporting 5.26 the lowest value. Through analyzing 1620 possible combinations of cement,

Miatto et al., 2016, reports the most recent concrete coefficient based on analyzing possible concrete mixes constructed from the different types of standard concrete.

To estimate the amount of sand and gravel domestically extracted in Antigua & Barbuda, the sand and gravel input used for the concrete related elements of asphalt production in the transport infrastructure and within building sublayers are accounted for in the following equations respectively:

$$2. \text{ Sand and gravel input}_{\text{asphalt}} [\text{t}] = \text{DMC asphalt} [\text{t}] \times \lambda_{\text{asphalt}}.$$

$\lambda_{\text{asphalt}} = 51.12$ (Miatto et al., 2016).

$$3. \text{ Sand and gravel input}_{\text{sublayers}} [\text{t}] = \text{DMC cement} [\text{t}] \times \lambda_{\text{sublayers}}.$$

(Symmes et al., 2019).

$\lambda_{\text{sublayers}} = 0.42$ (Miatto et al., 2016).

The manufacturing and processing losses associated with the domestic extraction of both sand and gravel, in addition to the separation process, prior to mixing the elements into the cement mixture is taken into consideration prior calculating the total quantity of domestic extraction (Symmes et al., 2019). Krausmann et al. (2017, supporting info) estimated a 4% manufacturing loss during this process. Therefore, the equation for estimating the total domestic extraction of sand and gravel is as follows:

$$4. (\text{Sand and gravel input}_{\text{concrete}} + \text{Sand and gravel input}_{\text{asphalt}}) * 0.96 + \text{Sand \& gravel input}_{\text{sublayers}}.$$

3.1.6 *Grossed Addition to Stock (GAS) based on domestic material consumption (DMC) values.*

GAS values from 2006-2017 were calculated as materials added to the economy's stock each year minus manufacturing and processing loss rates for each applicable material category. The processing loss rates account for the conversion losses of raw material into primary inputs to stocks and the manufacturing losses of inputs into stock (Krausmann et al., 2017). The loss rates are presented in a Table S3 of the appendix from the Material Inputs, Stocks and Output (MISO) model discussed in Krausmann et al. (2017). The loss rates in the table differ according to the material categories used by the Eurostat classification system (biomass, metals, non-metallic minerals). The stock building materials applicable to this study were sand and gravel in addition to limestone, clay, and gypsum used for concrete, cement, and asphalt production. Limestone,

gypsum and clay reported 44% in processing losses and 4% in manufacturing losses while sand and gravel only reported a 4% in manufacturing losses. No metal ores were imported, only processed metals. Processing and manufacturing losses of processed metals being imported occurred within the country of origin outside of A&B's system boundaries. Therefore, the processed metals manufacturing and processing loss rates were not including in the GAS calculation.

3.1.7 *Net Additions to Stock (NAS)*

NAS is defined as the annual amount of material input into the stock, which expresses the net expansion of the material stock (OECD, 2008a). Lwin, Hashimoto and Citesser (2013) describes NAS as an indicator measuring the physical growth of the economy by quantifying the weight of additions such as new construction materials accumulating within buildings and other infrastructure. NAS functions as a balancing indicator between additions to and removals from stock and may be viewed a proxy of future flows that become waste or secondary raw materials. NAS takes into account material flowing into the economy, leaving the economy as well as materials that return to the environment (SEEA., 2019). In this study, NAS takes into account the residuals or removals from stock; where removals were represented by construction and demolition waste recorded by the National Solid Waste Authority in Antigua & Barbuda from 2006-2017.

3.2 Social and Ecological Performance

The Safe and Just Space framework proposed by (Raworth., 2012) focuses on examining the space between the environmental boundary (environmental ceiling) and the social foundation which lies a socially just and environmental space for humanity's survival and fosters adequate sustainable economic development. In a recent study by Jia., (2019) the Safe and Just Space framework was used to assess the environmental and social performance on 5 Caribbean island states. A total of 7 environmental and 11 social indicators were utilized for each small island states. This study focuses on 5 of the indicators (outlined in Table 4), to compare the material consumption trends in the MFA with additional environmental and social performance indicators. This analysis examines infrastructure development beyond the scope of GDP through the use of social and natural metrics in order to understand the full picture of the construction material consumption within the socio-economic environment.

Table 4: Social and Ecological Indicators Used to Examine the Social and Ecological Performance

<u>Environmental Indicators</u>	<u>Definition</u>	<u>Data Source</u>
CO₂ Emissions	Carbon dioxide emissions is one of the main gasses contributing to global warming which is released from burning fossil fuels. Emissions include carbon dioxide produced during consumption of solid, liquid, and gas fuels and gas flaring. However, it excludes emissions from land use such as deforestation.	World Bank Data Bank (2006-2014).
Ecological footprint	An indicator measuring the amount of water and land available in the world in relation to the actual amount used by the population of a country. The Global Footprint network estimated 1.7 global hectares (gha) per capita/year as the available biocapacity per person on the planet.	Global Footprint Network. (2006-2013)
<u>Social Indicators</u>		
Healthy Life Expectancy	Life expectancy is total number of years an individual is expected to live a healthy life without facing life threatening diseases.	World Bank Data Bank (2006-2017).
Education	Secondary school enrollment completes the provision of basic education that began at the primary level and aims at laying the foundations for lifelong learning and human development, by offering more subject- or skill-oriented instruction using more specialized teachers.	World Bank Data Bank. (2007-2012,2014-2015,2017)
Fresh Water Availability	Most SIDS face water stress and scarcity (UNEP, UN DESA and FAO, 2012). Water scarcity was measured at 1000 cubic meters per capita in 2007, water stress is measured at 1700 cubic meters per capita and water abundance is measured greater than 1700 cubic meters per capita.	Small Island Developing States in Numbers (UN-OHRLLS.,2015).

Food supply	The dietary energy supply kcal/capita/day) is an indicator estimating the number of calories from foods available for human consumption.	Food and Agriculture Organization (2006-2017)
--------------------	--	---

3.3 Methodology for material stock analysis (MSA) of buildings

This section outlines the approach taken to quantify the building stock in Antigua & Barbuda for 2004. The 2004 building footprint layer was the most previous updated footprint layer available for the island and was utilized for the study’s MSA. The methodological framework for the material stock analysis follows a bottom-up, stock driven approach similar to Mesta et al. (2017). A building classification system was first developed to categorize the building footprints for the entire island into their respective building use-type classes. Physical data on these buildings were gathered, including the number of floors, area of the building, and the gross floor area (GFA). The building footprint classification step and assigning storey levels for the height assignment were two steps most prone to error. These potentials errors are further discussed in section 3.4 and 3.6.

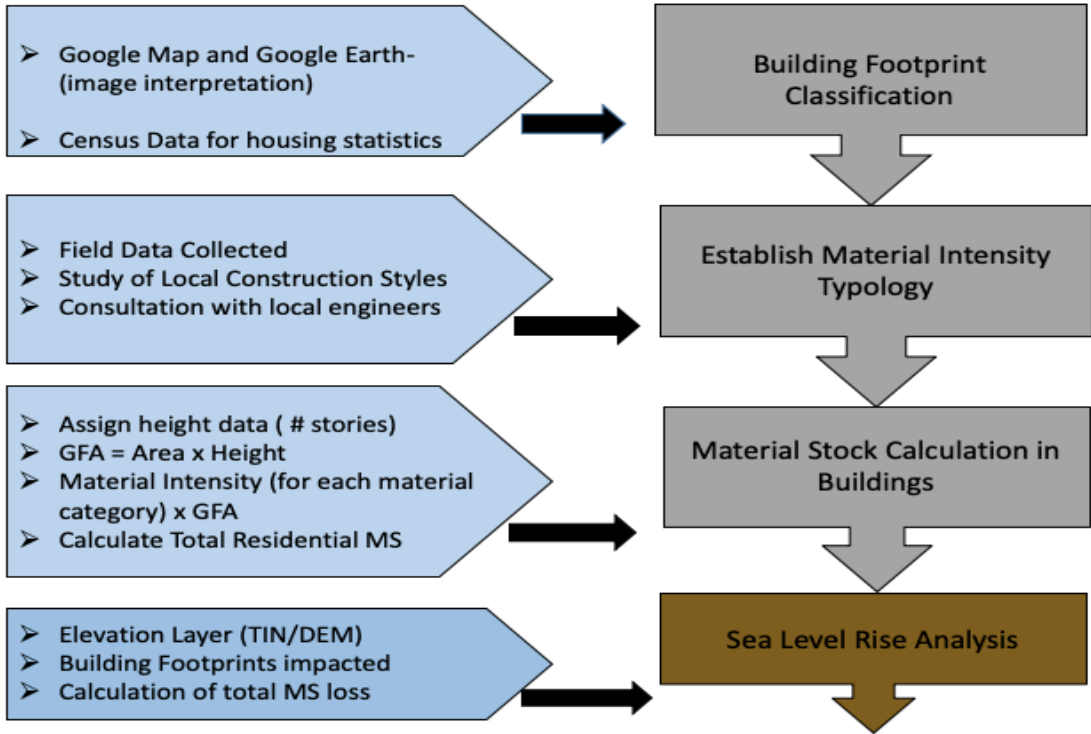

Figure 6: A general overview of the GIS adapted methodology used in calculating the building Material Stock and Sea level Rise Analysis in Antigua & Barbuda.

Material intensity typologies (MIT) were generated based on the local construction styles practiced within the country under the varying building-use type classes. The MIT separated the material intensities (MI) by four main categories of construction materials (aggregate, wood, concrete, steel). GIS tools were adopted to calculate and map the spatial distribution of the total estimated material stock within the island through showing the following:

- The MS separated by each building material category.
- The total stock of in-use construction materials in buildings for 2004.
- MS broken down by building use-type.
- Spatial distribution of MS on the island.

Lastly, the vulnerability of these stocks was primarily analyzed based on sea level rise scenarios used to assess the building classes that are most vulnerable on the island and further locating where these at-risk material stocks are situated. To achieve the material stock estimation for the country a wide range of geospatial and statistical data were collected and analyzed, and these datasets are outlined in Table 4.

Table 5 :Data files and data sources used for calculating the material stock analysis of buildings in Antigua & Barbuda.

Data Files	Data Source
Building Footprint Layers (2004)	Department of Environment (DOE)
Road Network	DOE
Land-use	DOE
Building Footprint Layer (2008)	OpenStreetMap
Field Photos	Fieldwork
Aerial Images	Google Street Map and Google Earth
Census Data: Housing Statistics	Division of National Statistics
Material Intensity	Field Work and Informal Interviews

3.4 Building footprint classification

The building shapefile for Antigua & Barbuda provided by the DOE consisted of over 60,000 building footprints. This original building footprint data set only provided information on the area, perimeter, and feature³ attributes of each building footprint; as a result, all building footprints were considered “unclassified” in the absence of assigned categories describing their use-type role. To successfully group and label all the buildings to their corresponding building use-type classes, a classification system was developed for the island. It consisted of two main components: the interpretation and analysis of remote sensing satellite imagery, and local knowledge of the physical infrastructure in Antigua & Barbuda. Image interpretation included the analysis of basic elements such as shape, size, pattern (spatial distribution), and association of the building footprints on external mapping platforms. The building footprint layer from the DOE acted as a base map during the building classification process. The Open Street Map building footprint layer functioned as a reference map to compare and analyze with respect to the building footprint layer provided by the DOE to provide greater detail during the classification process. Due to the large number of building footprints present, the building footprints were classified in sections where specific patterns were observed. For example, schools which are usually identified by large rectangular playing fields in the middle of school’s ground, churches and cathedral can be identified by their irregular shapes and sizes. Additionally, being familiar with the lay of the land and local development can assist in identifying patterns. For example, within most villages there is a health clinic, several churches, schools, and small shops. This information was very resourceful in identifying these specific building footprints. The key elements adopted by the research during the image interpretation of the building footprints are further described and summarized in Figure 8.

The feature attribute in the building footprint dataset identified each building under one of three categories including, “buildings”, “construction”, and “ruin”.

Classification Code:300- Tourism/Hotel
Building Typology 2: 320-Small-scale villas and condos

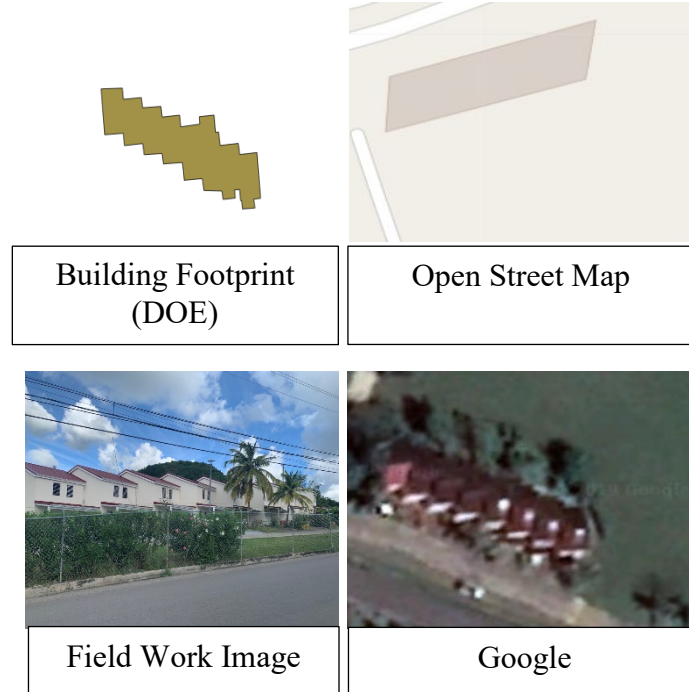

Figure 7: Features of the Image Interpretation and analysis of remote sensing imagery for classifying building footprints in Antigua & Barbuda

The use of mapping services such as Open Street Map (OSM) and Google Maps provided supplementary geographic data at more defined scales. It offered additional information such as the location tags of basic areas including hospitals, banks, airports, shops, hotels and other points of interest. The use of road network data and land use layers alongside the geospatial data provided by Google Map and OSM catalyzed the overall classification process. The use of both online remote sensing platforms, presented discrepancies and other areas of error within the classification process of the building footprint using data layers from OSM, Google Maps and the DOE including the following:

1. Accuracy of building footprint shape- the building footprint layers provided by the two online mapping services lacked details in the shape of their polygons in matching the shape of the actual buildings on the ground. In Figure 7, the building footprint provided by the DOE shows a more accurate representation of the respective building displayed in the field photos and google satellite photos; where the serrated edges of the building are shown, but absent within OSM. The increased

accuracy of shape details in the DOE data layer permitted a clearer and more defined distinction between individual building footprints.

2. Accuracy in building identification and use-type classification- in absence of local knowledge of the study area and relying solely on the OSM as the main tool in assisting to identify and label buildings presents some accuracy issues. OSM is open source which means it is readily available for public use where users can edit the map, and place locations tags/identifier on buildings, without actually visiting the study area or knowing if location tags are correct.
3. Missing building footprints- there were a few cases where building footprints within the DOE data layers, and on google satellite maps were not present on the OSM layer. In addition to the OSM layer representing the building footprints valid for A&B for 2019 and the DOE data footprint layer was valid for 2004.

An overlay analysis of the unclassified building layer and that from the 2018 building footprint provided by Open Street Map assisted in capturing (or distinguishing) buildings that were not present in 2004, to prevent an inaccurate assignment of building-use type categories. It is important to note that the remote sensing images on the mapping services platform were restricted to aerial views of the buildings/landscape. The fieldwork described in section (3.7) helped to validate the information captured through the image interpretation process, coupled with the researcher's local knowledge.

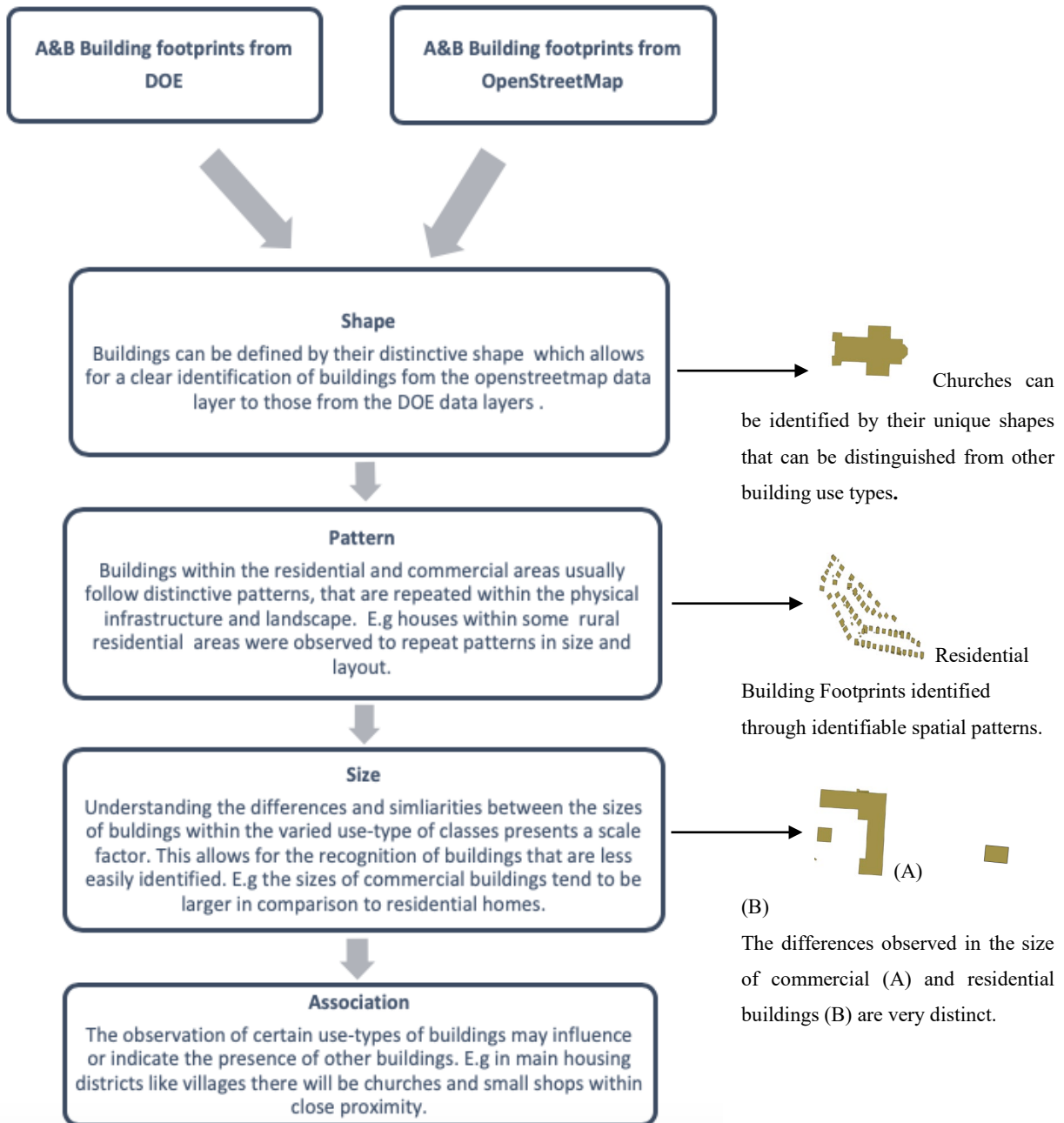

Figure 8: Key elements analysed by the researcher through the image interpretation of Antigua & Barbuda's building footprints.

3.4.1 Building use type classes

The second step in calculating the material stock was to establish the building use-type classes after the image interpretation analysis of the building footprint layer. The classification system of the buildings follows a hierarchal system consisting of three levels. The first level, Building-Typology-1 is the main building class, the second level, Building Typology-2 is the

groups and Building Typology-3 is the sub-groups. The building use type classes can be found in Table 6.

Table 6: The classification codes and building use-type classes for Antigua & Barbuda.

Code	Building Typology-1 (Building Class)	Building Typology-2 (Groups)	Building Typology-3 (Sub-groups)	Number of Floors	
100	Institutional	110-Church		1	
		111- Cathedral		2	
		120-Government Offices		2	
		130- School	131-Primary		2
			132-Secondary		2
			133-Primary& Secondary		2
			134-Tertiary		2
			135-Special Needs		2
		140- Medical Facilities	141- Hospitals		3
	142-Health Clinics		1		
150-Correctional Facilities	151-Police Station/Military		2		
160-Fire Station			2		
200	Transport	210-Bus Station		1	
		220-Seaport		2	
		230-Airport		2	
300	Tourism	310-Large-scale multi building hotels		3	

		320- Small-scale villas and condos		2
		330-Tours & Excursion		1
400	Protected Areas	(National Parks)		1
500	Commercial	510-Restaurant/Fast Food		1
		520-Banks		2
		530- Businesses		1
		540-Shopping Mall/Complex		1
		550-Commercial Mixed Use		2
600	Sports and Recreation	610-Community Centre		1
		620-Stadium		2
		630-Sports Complex		1
		640- Entertainment/Cinemas		3
700	Historical Sites	701- Museum		2
		702-Historical Landmarks		1
800	Residential	810-Rural-area single family dwelling		1
		820-Urban area single family dwelling		1
		830-Rural Residential area family dwelling		2
		840- Townhouse dwelling unit		1

		850-Business and Dwelling		2
900	Industrial	901-West Indies Oil Company (WIOC)- 901 902-Antigua Public Utility Authority (APUA)		1 1
1000	Other	1000-Costruction 1001- Not-in use		

3.5 Material Intensity Typology

Material intensities (MIs) are reported as the weight of construction material measured in kilograms per gross floor area (GFA) (kg/m²) (Heeren & Fishman., 2019). These two parameters reflect the material composition and the size of buildings in the country, which are necessary components in estimating the building material stock (Mesta et al. 2017).

Information on the material composition was based on data from housing statistics presented in the national census, field work, and on-site observations, and expert consultations with local civil engineers. The material intensities were described through eight main material intensity typologies which reflected the local construction styles practiced in Antigua & Barbuda, in (Table 10). The material intensity typologies are separated by different structural components within the superstructure including the floors, walls, roof, roof coverings as well as the foundation. Buildings in Antigua & Barbuda are not built with basements, and therefore not accounted for in the material typologies and the research. Building plans, architectural drawings, and additional technical information were collected on local building structures to develop the corresponding material intensities in Table 10. The appendix outlines the steps taken to calculate the material intensity for each of the five structural components and assumptions made in these steps. After defining the material intensity typologies, the estimated material stock was calculated through the following equations using ARC-GIS:

Equation 1: Gross Floor Area for a building footprint (b) is calculated as follows:

$$\text{Building Footprint Area } (b) \times \text{The number of floor stories } (b).$$

Equation 2: Material stock measured per material category (m) (aggregate, timber, concrete or steel) for a building footprint (b) is calculated as follows:

$$GFA (b) \times MI(m)$$

Equation 3: Total Material Stock for a building footprint (b) is calculated by the sum of the material stock measured per material category (m) (aggregate, timber, concrete and steel):

$$\begin{aligned} MS &= \sum MI_{(b,m)}. \\ &= MI_Aggregate_{b,m} + MI_Timber_{b,m} + MI_Concrete_{b,m} + MI_Steel_{b,m} \end{aligned}$$

The material stock for all the building footprints is calculated as the sum of all the total material stock for all buildings.

3.6 Height Assumptions

In this research, without the absence of actual height measurements of the building footprints, the number of stories or floors within each building was used as a proxy for height measurements. Using the image interpretation technique, to determine the number of stories of each building footprint presented a tedious task. The remote sensing images on mapping platforms like Google Maps and Open Street Map mainly showed aerial photos of the buildings. Determining and counting the number of stories in a building is very difficult when the researcher's perspective is only from above with no indication of depth or a 3-D perspective of the buildings. Unfortunately, special viewing tools such as Google Street View, were unavailable for Antigua & Barbuda. Therefore, the assignment of the number of stories was guided by local knowledge and field work.

The number of stories were assigned based on each building group category, e.g., based on the second level of the building typology and based on the building sub-groups category (third level building typology) only for the 100-Institutional building class (see Table 4). Residential height data was assigned based on the field data collected, since 60% of the buildings visited on-site were classified as residential buildings. In the absence of height data, assumptions were made which contributed to sources of error. This included assuming all buildings within a specific typology class were assigned the same number to represent the number of floors within each

building under a specific building typology class. For example, all buildings classified under 130-School were assigned a total of 2 floors. Realistically all schools including primary, secondary, and tertiary would vary in the number of floors. This assumption can have a major impact on the material stock analysis that can be reflected in an overestimation or an underestimation of material stock values.

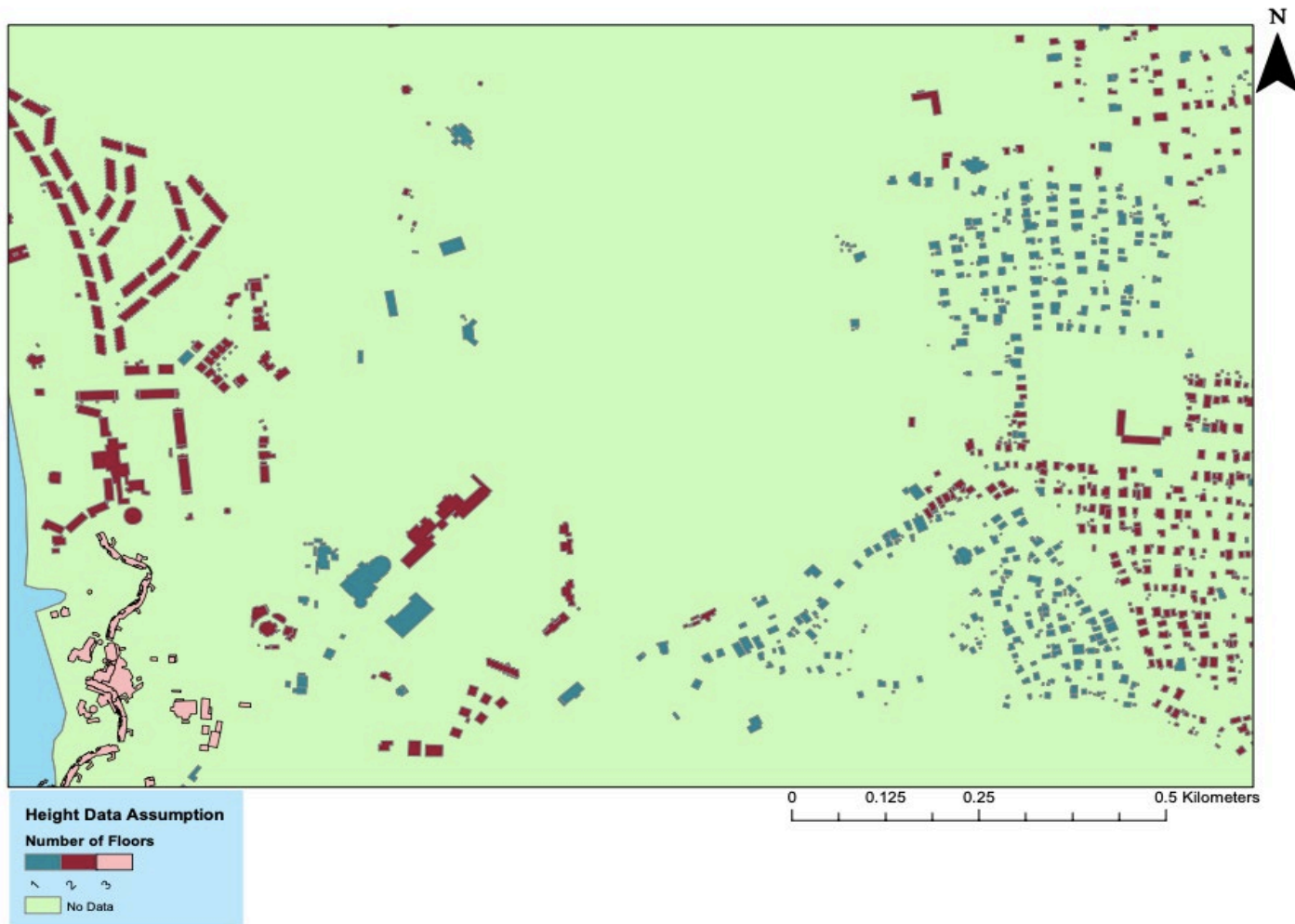

Figure 9: Height data assumption of the building footprints within the parish of St. John's, Antigua & Barbuda.

In Figure 9 it shows the distribution of the assigned number of floors in buildings on the eastern side of the country. The number floors are concentrated within clusters and is not reflective of the variations that would be observed if onsite, and ground truth data was collected to determine a representative distribution of floor numbers for this area. To address the uncertainty with the height data assumptions, a sensitivity analysis was carried out for all building groups within the

country in Table 11. Height measurements are multiplied by the area of the building footprint for estimating the gross floor area (GFA) and is required to calculate the total material stocks as an indicator of the physical size of buildings. As a result, inaccuracies in the GFA can strongly impact the material estimate.

3.7 Field Work and Building Height Assumptions

Field work was conducted over a one-week time span in Antigua & Barbuda, January 2019. The goals of the field work are as follows:

- 1) Visiting as many buildings as possible present in the 2004 DOE building footprint layer with the assistance of a handheld GPS unit. The GPS unit would have been updated with the building footprint layer prior departure for easier access and navigation on the field. The GPS helped with ground truthing and positive identification of the building footprints present on the 2004 data layer to what was actually present on the ground.
- 2) A qualitative database of observed findings was developed through recording data from each site-visit, in order to capture as much descriptive data as possible. Information on the number of stories, outer wall materials, roof coverings, garage present, paved driveway, hurricane shutters present were noted.
- 3) Field verification consisted of pictures taken at each building site, which were subsequently added to the database to capture the condition and features of the superstructure. The building use-type of these buildings were also recorded to verify with the image interpretation and overall classification system.
- 4) A total of 303 building footprints were visited by the researcher on the island where the spatial distribution of sites visited is shown in Figure 10. The sample size of building footprints visited, provided a foundational basis in assigning average height (story number) for each building use-type class (especially focusing on the residential class) shown in Table 6.
- 5) After data collection, a local civil engineer focused within the construction field was consulted to establish the material intensity typologies based on site observation and professional expertise.
- 6) Information was collected from local government agencies such as the Developmental Control Authority (DCA) on building permits for institutional and commercial buildings from 2006-2017.

Table 7: A breakdown of the building footprints (BF) visited on the field based on the buildings-use type categories and average number of stories observed.

Building Class	Building Typology-1	Average Number of Floors	Standard Deviation	Minimum Number of Floors	Maximum Number of Floors	Sum Number of Floors	Total Number of BF Visited	Percentage (%) Count of BF
Institutional	100	1.60	0.49	1	2	16	10	3.30
Tourism	300	1.97	0.91	1	6	59	30	9.90
Commercial	500	1.75	0.84	1	5	128	73	24.09
Sports & Recreation	600	3.00	0.00	3	3	3	1	0.33
Historical Site	700	2.00	0.00	2	2	2	1	0.33
Residential	800	1.43	0.51	1	3	264	184	60.73
Other	1000	1.75	0.42	1	2	7	4	1.32
Total						479	303	100

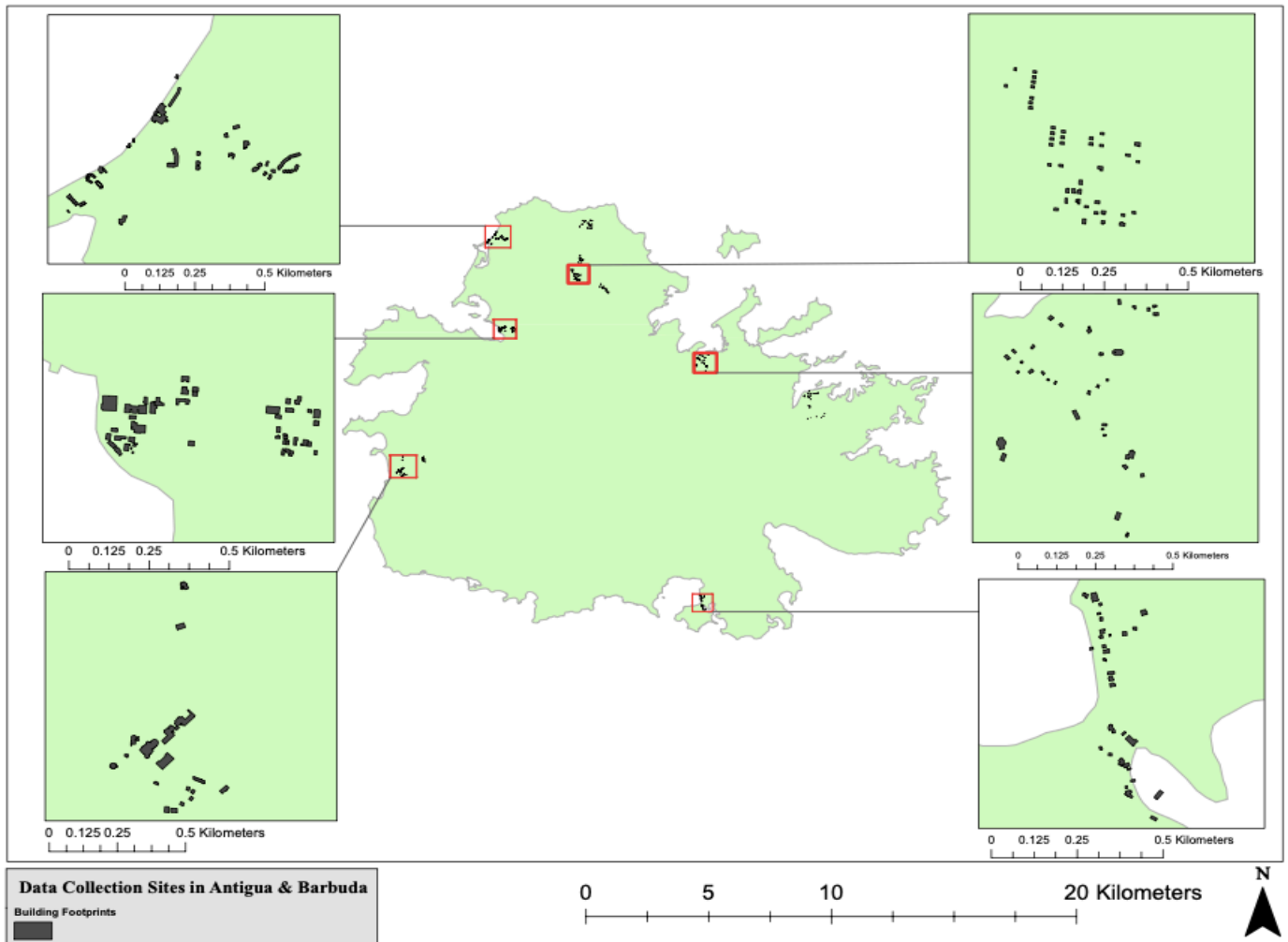

Figure 10: Spatial Distribution of the data collection points of each building footprint visited in Antigua & Barbuda.

3.8 Residential Material Intensity Distribution

Housing statistics in the 2001 National Census outlines the outer wall materials of household dwellings in Antigua & Barbuda. This data was used to determine the material intensity typologies distributed amongst the residential sector. The residential sector plays a dominant role within the material stock, after observing that 90% of the building footprints were classified as residential dwellings. 50 % of houses were observed to be wood structures, 30% Concrete Structures and the remaining 20% Concrete/Timber Mix; as a result of the percentage of household's values being rounded to the nearest 5% (Table 8). The simplification was a consequence of two other existing typologies that were observed within the residential building class in Antigua & Barbuda. The two additional material typologies were categorized as Manufactured Materials 1 and Manufactured Materials 2. Although these material intensity typologies were defined there was not available information in determining their intensities as well the predominant use of polyvinyl a synthetic plastic polymer used within these structures. The scope of the thesis only focused on aggregates, wood, steel, and concrete and did not include plastics, in addition to the Manufactured Materials typology class only representing a small percentage of the residential buildings less than 1%.

Table 8: The distribution of the material intensity typologies within the residential building class based on the outer wall materials of household dwellings

2001 Census Outer Wall Material	Number of Households	Percentage of Households	Material Intensity Typology	Nearest 5%
Concrete & Blocks	6,412	32.2	Concrete Structure 1. - 13% Concrete Structure 2. – 15% Concrete Structure 3. – 2%	30
Wood	8,965	45.0	Timber Structure 100%	50.0

Wood and other material	4,410	22.1	Concrete/Timber Mix Structure.	20
Other	154	0.8		0
Total	19941	100		100

To assign the material intensities respective of the 0.5, 0.3, and 0.2 probability, these categories had to be randomly assigned. The material intensities were randomly assigned in the absence of on-site field visits to accurately assign the specific material typologies to their respective building footprint on the ground. To evaluate the uncertainty of the random assignment, the MIT were assigned by a Monte Carlo simulation which was completed through R-code, to calculate the residential material stock based on multiple iterations. This step indicates how important it is to accurately assign the material stock typologies to prevent in overestimating or underestimating the total material stock estimate. The final number used to represent the residential building class based on the Monte Carlo simulation was 2,475.64 kilotonne (kt). The number of iterations included 10, 100, 500, 1000, 5000, 10,000 and 20,000. The code used to run the Monte Carlo simulation is provided in section 8.3.

3.9 Mapping Spatial Distribution

Building classes, height data, GFA, and material intensities were added as feature classes to the 2004 building footprint layer computed in an ArcGIS software environment. This facilitated in the creation of maps for the spatial distribution of the building stock on the island. Two national scale maps were developed:

- 1) Showing the spatial distribution of the total material stock in Antigua through 100 m² cells.
- 2) Local scale maps of the capital city of St. Johns showing the differences between the density of material stocks accumulated under the four general classes of the construction material (aggregate, timber, concrete, and steel).

3.10 Estimating Vulnerable Building Stock

3.10.1 *Sea level Rise Analysis*

This sub-section explains the steps taken for analyzing the building stocks vulnerable to potential sea level rise (SLR) in Antigua & Barbuda. SLR occurs as a result of the ice melting from small ice sheets and from glaciers as well as oceanic thermal expansion (Worldbank, 2019). Coastal ecosystems and communities will experience significant impacts such as a loss of infrastructure and extreme events in coastal areas as a result of rising sea levels in association with other climatic drives such as extreme flooding, precipitation and temperatures (ECLAC., 2019). NOAA research on global sea level rise projections estimated a global sea level rise of approximately 2.0 meters by 2100 (Parris et al. 2012). Parris et al. (2012) estimated their highest scenario of sea level rise based on the estimated ocean warming and the IPCC AR4 global sea level rise projection in addition to calculating the greatest glacier and ice sheet loss by the end of the century. In comparison to other places in the world, the Caribbean is expected to experience greater SLR as a result of its geographical location and proximity to the equator and other geophysical factors (Simpson et al., 2010). 1m and 2m intervals were chosen based on the four scenarios presented by Parris et al (2012) for 2100. The four scenarios which included the lowest scenario-0.2m, intermediate-low-0.5m, intermediate-high-1.2m, and highest-2.0m. The highest SLR scenario measured at 2m was used as a threshold value to represent the worst scenario and outcome on the island, and the average of all four scenarios was estimated at approximately 1m to represent as an intermediate amongst all the projected scenarios.

The SLR analysis helps to identify which buildings are vulnerable, where these buildings are located, and what are the services provided by these buildings that are at high risk. After establishing the platforms for spatial distribution in the previous sections, they serve as critical steppingstones for assessing the vulnerability of the building stock.

In ArcGIS, a triangular irregular networks (TIN) file containing elevation data for Antigua was sourced from the DOE and converted to a raster file through the ⁴“TIN To Raster” tool. The “Reclassify” tool was used to reclassify the elevation data from 0-1m, with the

⁴ “TIN To Raster converts a triangulated irregular network (TIN) to a raster through interpolation. Every cell in the output is assigned a height or NoData value depending on whether or not the cell center falls within the TIN's interpolation zone” (ArcGIS., 2016)

remaining height data classified as “no data”. This step assumes that elevation between 0-1m will be displayed and elevation data outside of this range will be represented as “No Data” or not displayed. The resulting data layer extracted will represent the 1m raster layer containing areas measured at 1 m or less in elevation. The raster layer was then converted to a polygon file to conduct an intersect analysis between the building footprint layer. The intersect tool overlaps the areas (or polygons) that are 1m and less in elevation with building footprints that fall within these areas. As a result, features are written into a new output feature class, the new data layer now depicts the buildings that could potentially be impacted by a proposed 1m sea level rise. These steps were repeated for the 2m level rise analysis. This methodology was adopted in the absence of shoreline data and accounting for hydrological connectivity to the sea as utilized in previous research (Lichter & Felsenstein., 2012; Poulter & Halpin., 2007; Gesch.,2009). Antigua & Barbuda, the main assumption is this approach is that TIN file or elevation layer correlated with the hydrological layer. This approach was used for informative purposes to identify potential areas that would be impacted by a 1m and a 2m rise in sea level rise. Additionally aspects such as coastal erosion, shoreline erosion and recession, and the hydrological connectivity to sea considered as in previous research.

4 Results

This subsection presents the research findings based on the methodology outlined in Section 3 of the study. The following results are separated into three categories including: the material flow analysis (MFA), material stock calculation, and a sea level rise (SLR) analysis. The combination of these subcategories is focused on drawing the complete picture of construction material flows and accumulation used within the built infrastructure of Antigua & Barbuda. The SLR analysis examines the amount and type of material stocks that are threatened by exposure under projected sea level rise scenarios within the socio-economic environment. The three main categories of construction materials studied are timber, non-metallic minerals, iron, steel and other metals. The time period through which these materials were analyzed spanned from 2006 to 2017 which provides a time series account to capture the trends and patterns driving resource use of key construction materials within the context of a small island developing state. GDP and per capita values were used to compare material flows to economic growth, and to compare MFA indicators within a cross country analysis through studying the average material standards. GDP and population values were sourced from the World Bank's database.

4.1 MFA of construction materials (2006-2017).

4.1.1 *Imports*

The total amount of imported construction materials from 2006 to 2017 equals to 702 kilotons (kt), with the annual imports showing no apparent trend. Imports fluctuated from high to low points throughout the 11-year period showing an overall decline in imported construction materials as seen in Figure 12. In Figure 13 non-metallic minerals such as cement, asphalt and bitumen account for 59% of the total imports throughout the 11-year time span.

The annual amount of non-metallic imports ranged between 5-100 kt, in comparison to steel and other metals, with their highest imported quantities of materials measured at 14 kt and 6 kt respectively. The high quantity of imported non-metallic is attributed specifically to cement which constitutes 79% of the total amount of non-metallic minerals imported from 2006-2017. As a result of the country importing all of its cement to meet local construction needs and demands.

Wood, steel, and other metals show minimal variation in the quantity being imported, but the trend in non-metallic minerals imports showed greater spikes. The 2011 spike in non-metallic minerals comes after the passing of category 2 hurricane Earl in 2010 which amounted in 12.5

million USD of damages in Antigua & Barbuda (Cangialosi., 2011). The 2013 spike occurred concurrently with a 5% increase in the gross value added of construction activity including construction of modern library. The need for building repairs and damages in 2011 and an increase material imports to meet the demand of increased construction and business activity.

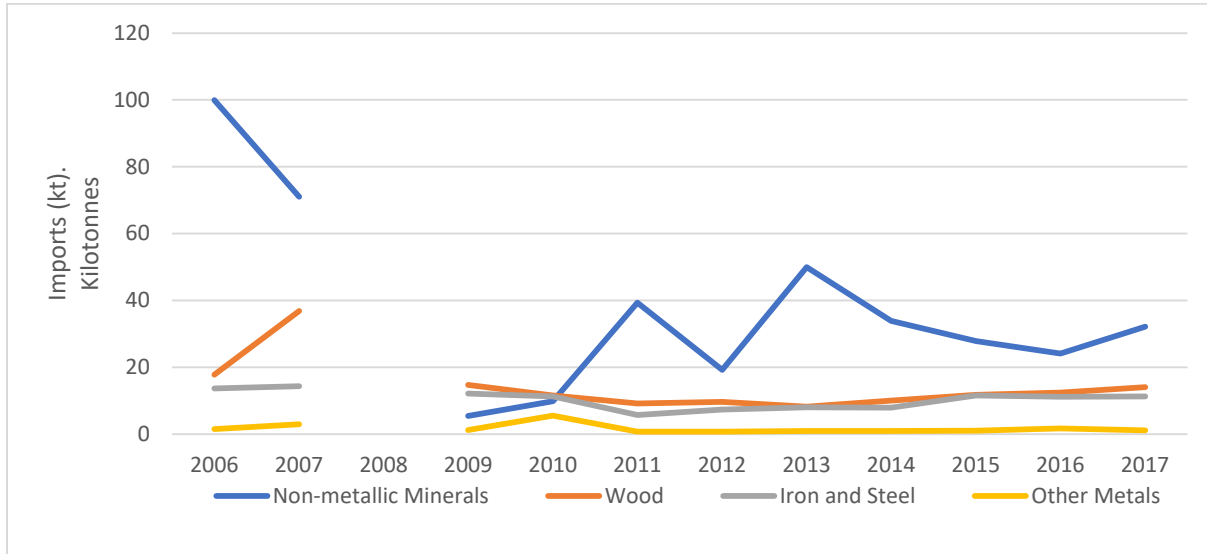

Figure 11: Illustrates the quantity of wood, non-metallic minerals, iron, steel and other metals imported into Antigua & Barbuda on the primary axis from 2006 to 2017.

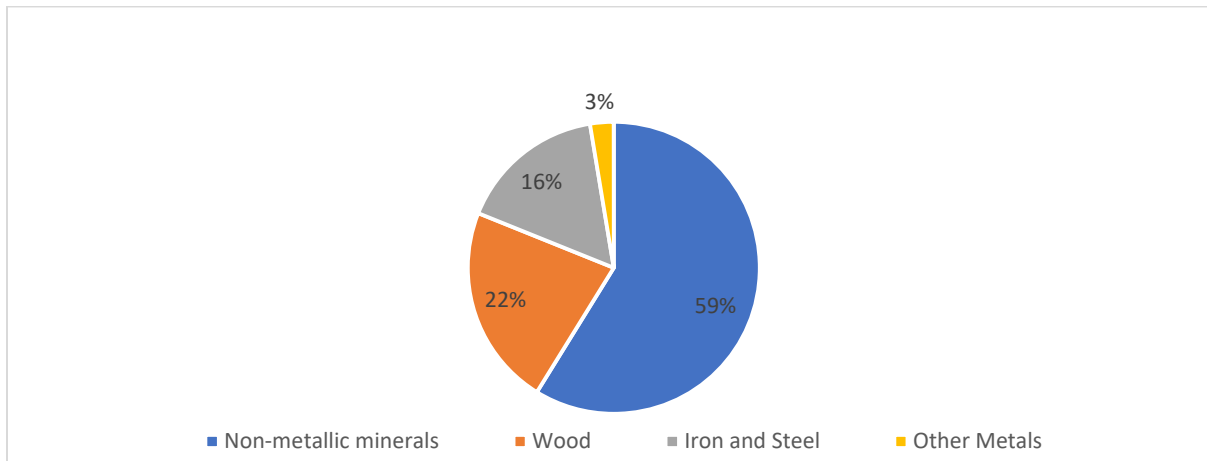

Figure 12: The percentage breakdown of imported construction material into Antigua & Barbuda from 2006-2017.

4.1.2 Exports.

In Antigua & Barbuda exports of construction materials from the island are minimal with exceptionally low quantities reported for each material category.

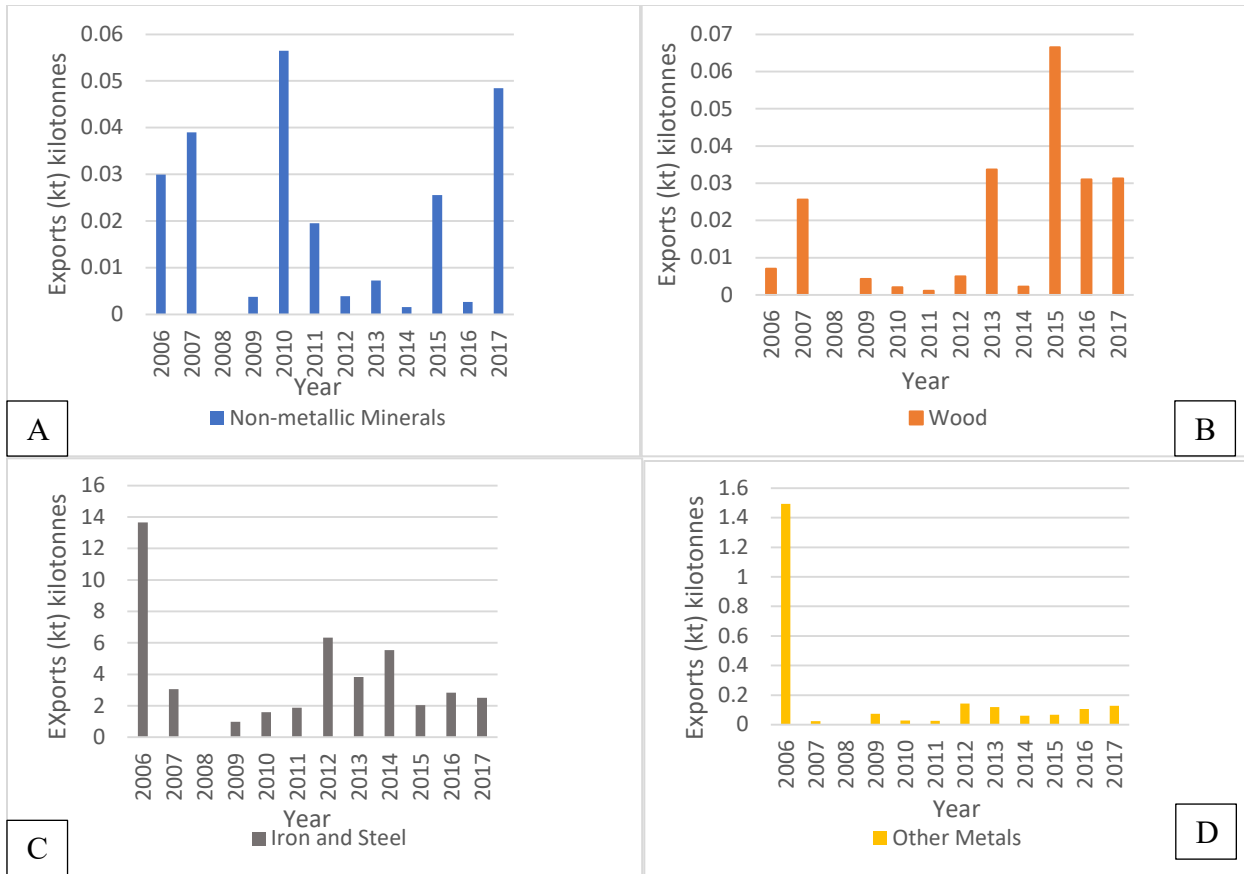

Figure 13: A breakdown of the four main categories of construction materials exported from 2006 to 2017 in Antigua & Barbuda: A represents non-metallic minerals, B represents wood, C represents iron and steel, and D represents other metals. Note the difference in scales.

This trend is distinctly observed between the differences in quantities of imported and exported materials as seen in the differences between scales in Figure 14. Iron and steel accounted for more than 94% of the total exports between 2006 and 2017. The iron and steel exports were traded mainly between other Caribbean islands and the EU-28, which is the second largest trading partner within the Caribbean region.

4.1.3 Physical Trade Balance (PTB)

In Figure 15, the patterns observed in the PTB are reflective of the trends observed within the imported materials, due to the low amount of construction materials exported from the country between 2006 and 2017 (Figure 14). Antigua & Barbuda relies heavily on importing construction materials, due to the limited span of domestic extraction within the country. In Figure 15, Similar to the imports of construction materials, non-metallic minerals constituted the highest portion of

the PTB at 63%. Therefore, with a high volume of material inflow and little to no apparent outflow, the PTB results in a net physical trade plus for Antigua & Barbuda.

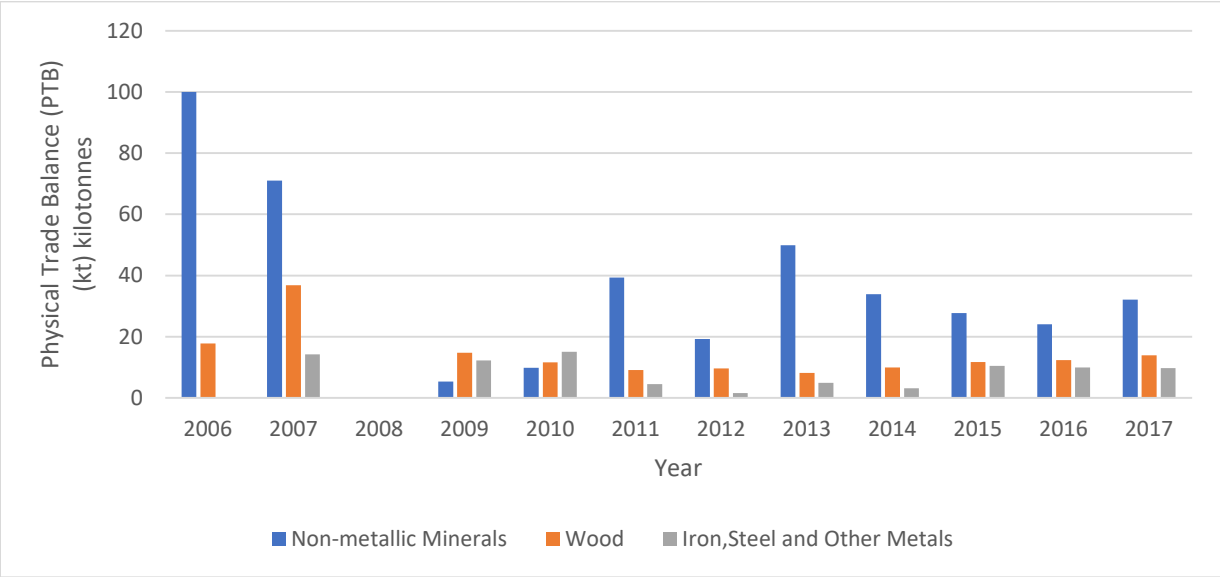

Figure 14: The Physical trade balance of construction materials imported and exported within Antigua & Barbuda from 2006-2017 plotted on the primary axis (right).

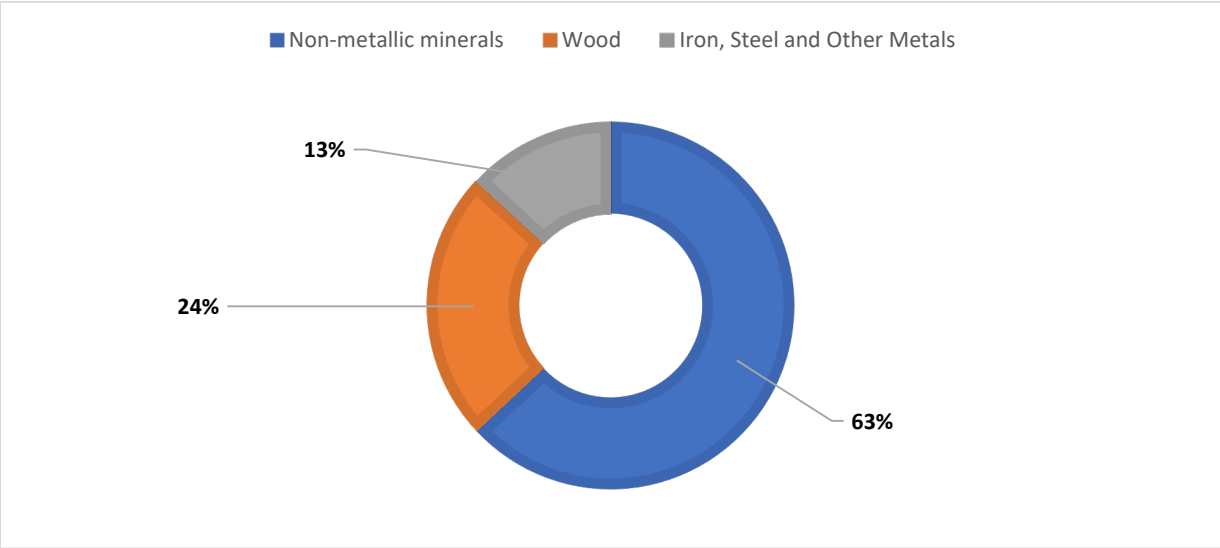

Figure 15: The percentage of construction materials contributing to the Physical Trade Balance (PTB) in Antigua & Barbuda from 2006-2017.

4.1.4 Domestic Extraction (DE)

In Antigua & Barbuda, domestic extraction of construction materials is limited to the production of non-metallic minerals such as sand, gravel, and asphalt. Figure 17 shows in 2006, the highest amount of sand and gravel domestically extracted amounted to 584kt. In 2009 the

lowest amount of domestic materials were extracted within Antigua & Barbuda at 115 kt, within the 2006 to 2017 time frame.

Figure 17 indicates that the greatest sum of sand and gravel is used for concrete production at 71%. The use of sand and gravel is additionally utilized within building sublayers at 23%, and asphalt production required by the transport infrastructure accounting for the remaining 6%.

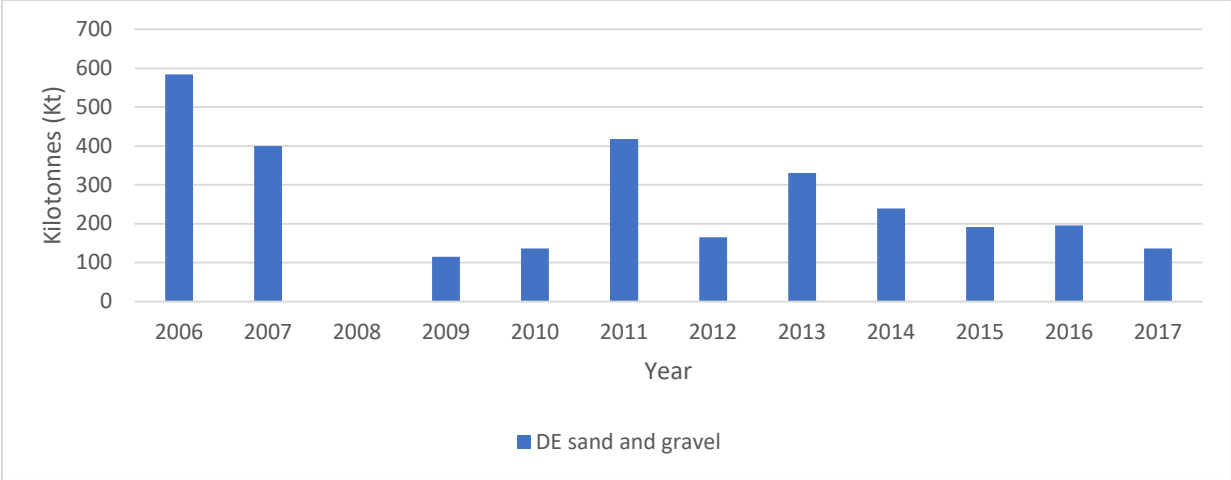

Figure 16: The domestic extraction of non-metallic minerals from 2006 to 2017 in Antigua & Barbuda.

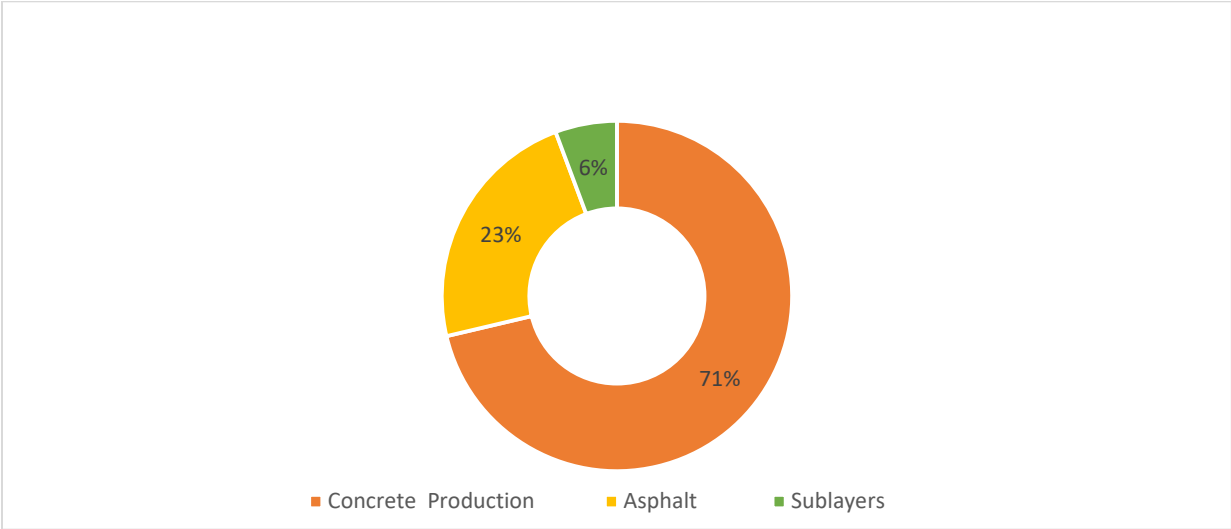

Figure 17: The distribution of sand and gravel used within different components of the built environment from 2006-2017 in Antigua and Barbuda.

4.1.5 Domestic Material Consumption (DMC)

Domestic material consumption shown in Figure 18, represents the total quantity of construction materials consumed within Antigua & Barbuda from 2006 to 2017 after domestic

extractions and exports have left the country. DMC and GDP indicators were used to examine the extent of material productivity of construction materials on the island.

In Figure 18 DMC declined 73% measuring at 702 kt in 2006 and 192 kt in 2017. Material productivity in Antigua & Barbuda showed an overall upward trend steadily increasing from 3.1 million USD/kt in 2013 to 9.0 million USD/kt in 2017, an overall increase of 61%. During 2008 to 2010, and 2014 to 2017 DMC and GDP show parallel growth trends, indicating dematerialization of construction materials, as the economy grows faster than material consumption. Relative decoupling of GDP from DMC was observed in 2006, 2007, 2011 and 2013, where material productivity measured lower than both GDP and DMC. Throughout 2006 to 2017, there was no apparent trend of absolute decoupling of GDP from DMC.

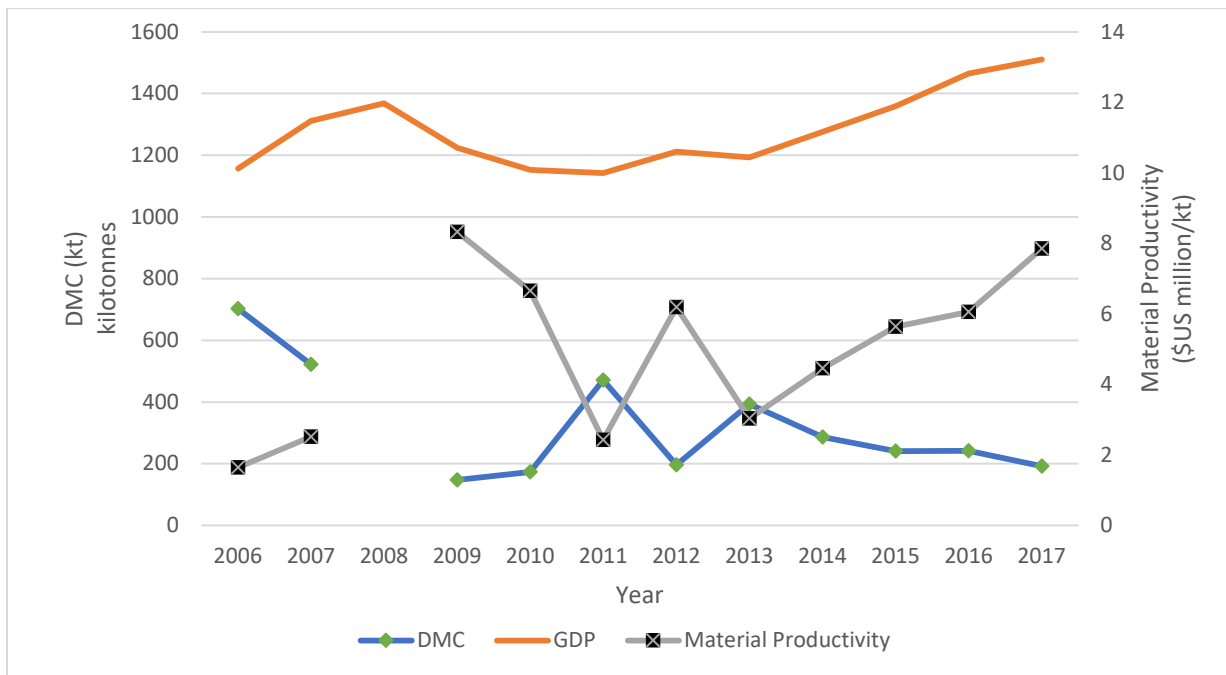

Figure 18: DMC and GDP are plotted on the right (primary) axis and material productivity (GDP/DMC) is plotted on the left (secondary) axis for Antigua and Barbuda from 2006 to 2017.

4.1.6 Gross Addition to Stock (GAS)

The gross addition to stock (GAS) observed from 2006 to 2017 in Antigua & Barbuda was estimated at 3,480 kt or 3.5 megatons (MT). GAS accounted for the manufacturing losses in sand gravel, limestone, gypsum, and clay specifically used in asphalt, concrete or cement production.

The GAS was primarily attributed to non-metallic minerals, which accounted for 93% of the GAS as seen in Figure 19, with an average per capita value of 3.5 tonnes (see Figure 20).

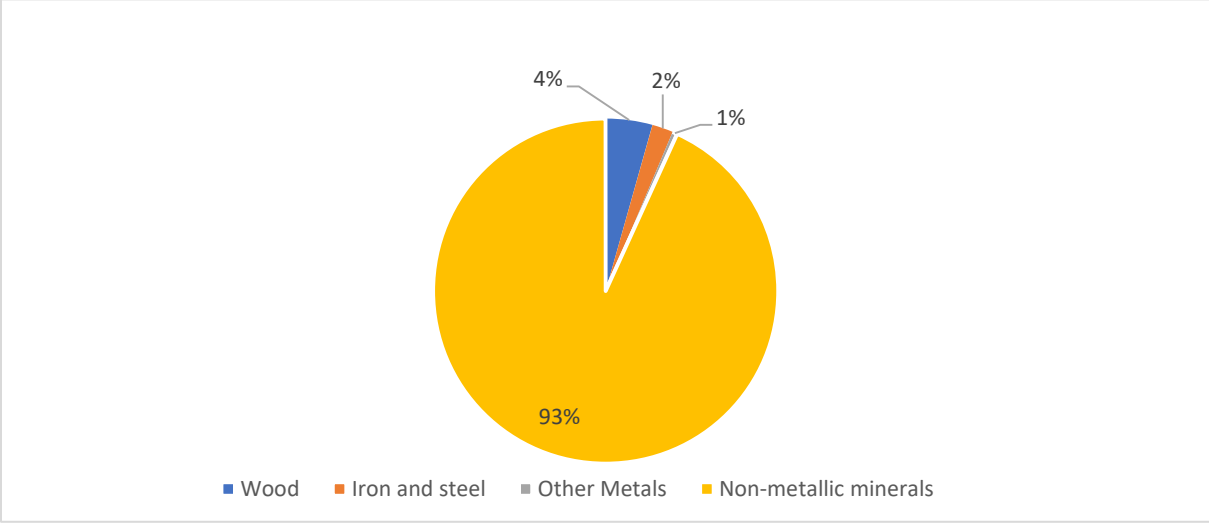

Figure 19: A Breakdown of the different categories of construction materials comprising the total Gross addition to Stock (GAS) in Antigua & Barbuda from 2006 to 2017.

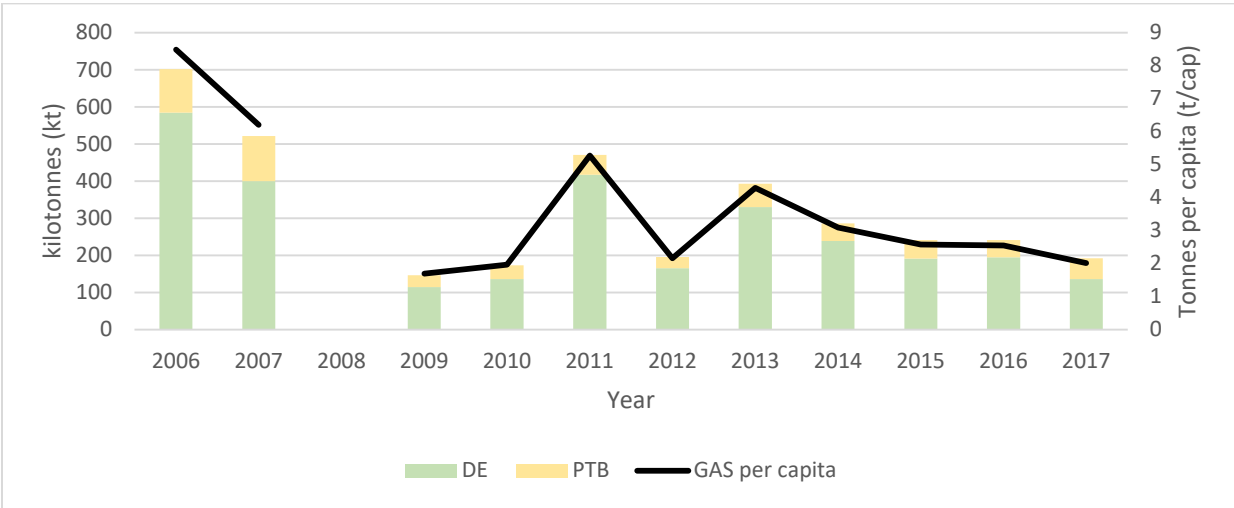

Figure 20: The distribution of gross addition to stock, compared between domestic extractions and the physical trade balance in Antigua & Barbuda from 2006 to 2017.

However, the high percent of non-metallic minerals contributing to the GAS is derived from the respective domestic extraction and physical trade balance values.

In Figure 20, GAS based on domestic extraction accounts for 82% of the total GAS, in comparison to the PTB which accounts for 20% of the total GAS from 2006-2017. In Figure 19, during this time period the material tonnes per capita (t/cap) added to stock experienced a gradual decline from 8.5 in 2006 to 2.0 t/cap in 2017. In Figure 21, it shows the gross addition to stock within all

four categories of construction materials have also decreased from the beginning of 2006 moving towards the end of 2017. The largest decline is the GAS were observed within non-metallic minerals and iron, steel and other metals in per capita values with a 79% and 39% decrease, measured at 6.5 and 0.07 t/cap respectively.

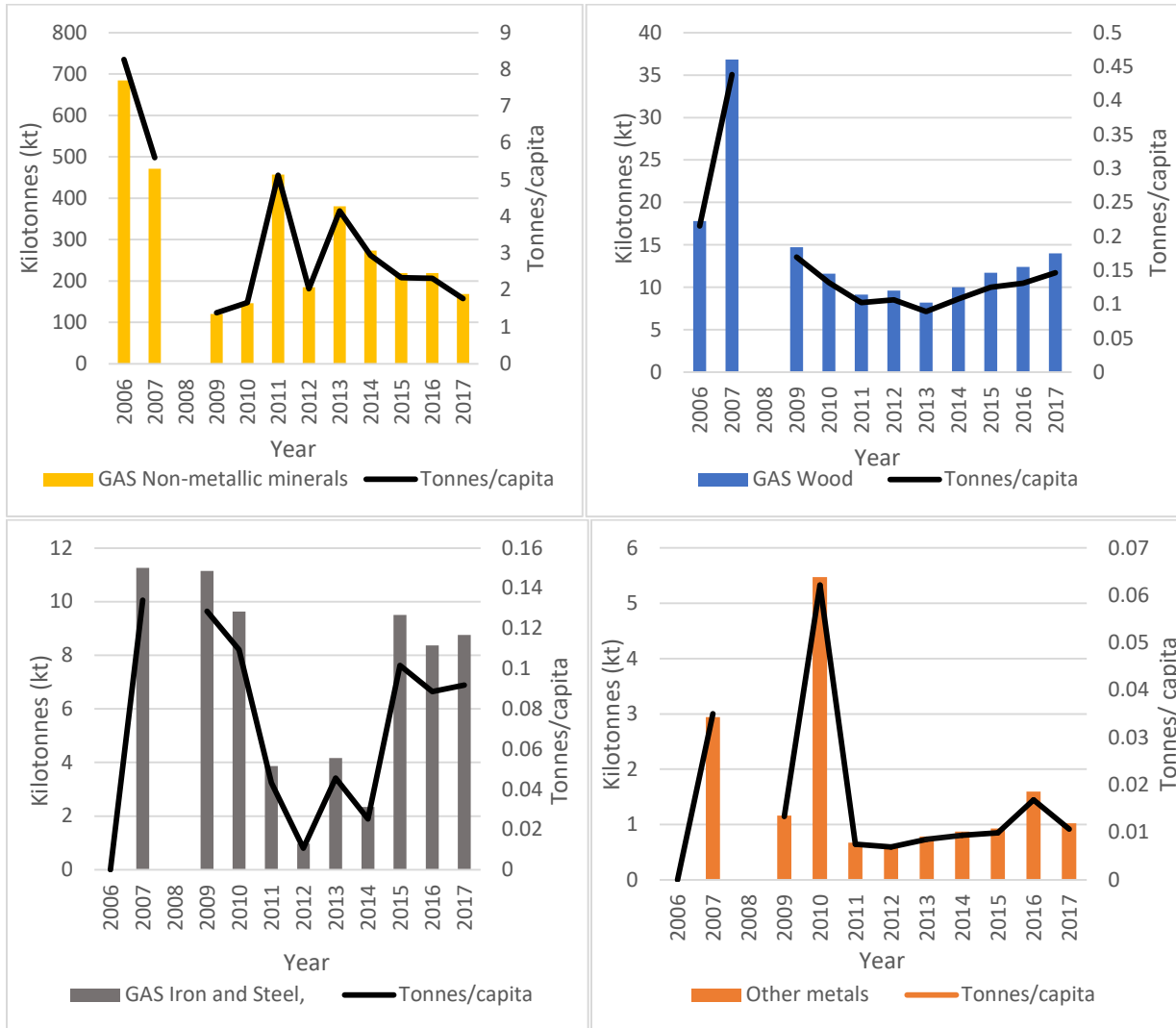

Figure 21: The trends observed within the Gross Addition to Stocks (GAS) for the four categories of construction materials in Antigua and Barbuda from 2006 to 2017. Note the different scales.

Non-metallic minerals are plotted in the upper left-hand corner in yellow, wood in the upper right-hand corner in blue, iron and steel in the lower left-hand corner in grey and other metals in the lower right-hand corner in orange. GAS measured in kilotons are displayed on the left axis and the tonnes per capita values are shown on the right-hand axis. The observed decline in GAS for A&B could be a result of decline investment into the physical infrastructure.

4.1.7 Net Addition to Stock (NAS)

The NAS of construction materials in Antigua and Barbuda is measured at 3,303 kt or 3.3 (MT) from 2006-2016, with periods of growth spurs and decline within the 10-year time frame. In Figure 22, the highest levels of construction materials added to the material occurred between 2006-2007 with an average of 7.2 t/cap. In comparison the latter end of the time series with an estimated 2.7 t/cap of construction material was estimated to be added to the stock each year between 2014 and 2016.

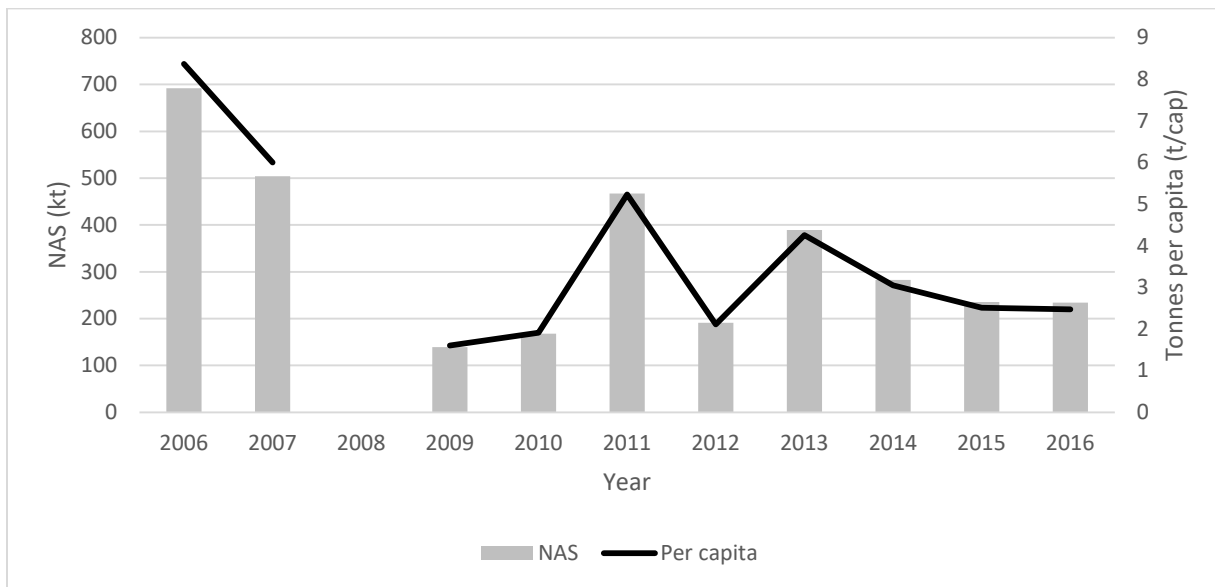

Figure 22: The trends in Net addition stocks (NAS) plotted on the right axis and the growth rates of NAS per capita plotted on the left axis for Antigua and Barbuda between 2006-2016.

4.2 Building Permits and Construction and Demolition (C&D) Waste

The focal point of this research is on construction material flows and stocks within Antigua & Barbuda. Building permits approved on an annual basis in relation to collected C&D waste on the island, can provide additional information on the dynamics of construction material flows from a local perspective outside of trade data. Building permits indicate the number of new buildings that have been approved for construction. Therefore, it can function as an indicator of resource demand of new construction that will need to be met by a supply of resources from local as well as international sources.

Figure 23 illustrates that a total of 4,911 building plans were approved from 2006 to 2017 in Antigua & Barbuda. Residential buildings accounted for the higher percentage of the total sq ft at 60%, in comparison to the commercial buildings which accounted for the remaining 40% of the

square footage added within the 11-year time frame. The total amount of approved building plans and permits, residential and commercial square footage have showed a general downward trend.

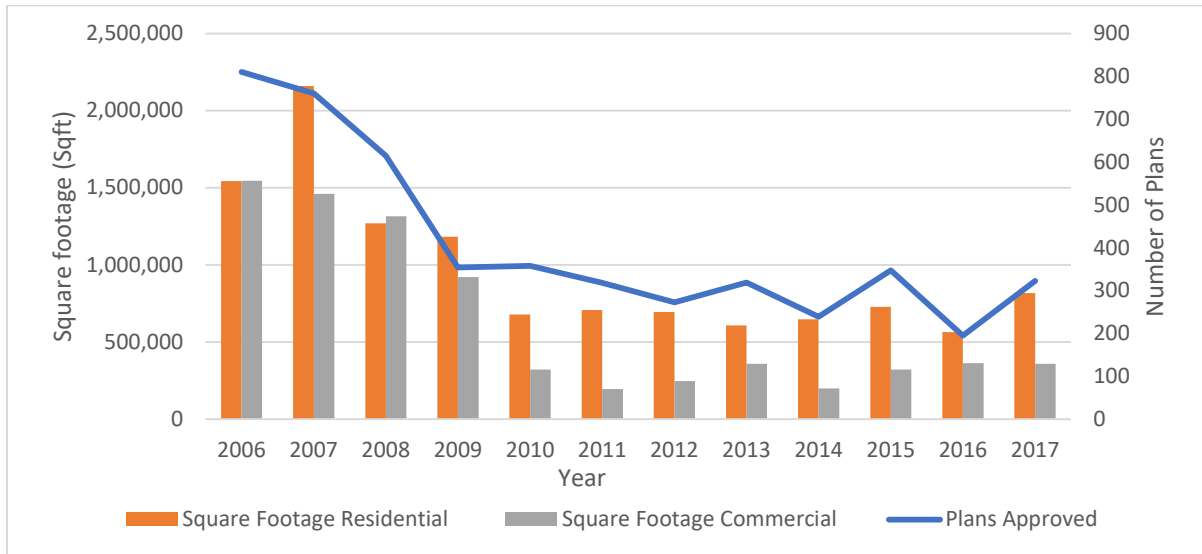

Figure 23: The total square footage of new residential and commercial buildings plotted on the primary axis (left) and the total number of approved building plans on the secondary axis (right).

In Figure 24, C&D waste decreased from 0.12 t/cap in 2006 to 0.08 t/cap in 2016. C&D waste was highest in 2007 at 17 thousand t which coincides to Figure 23 in 2007 where the highest combined total of square footage amounted to 13.6 million sq ft and the second highest number of building plan approvals at a total of 760.

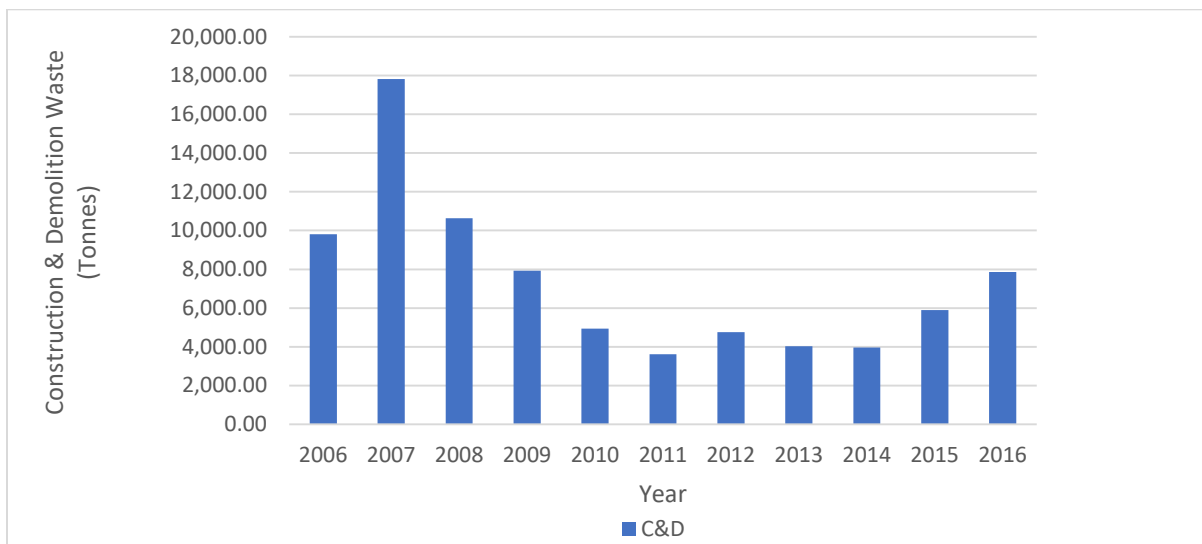

Figure 24: Construction and Demolition (C&D) waste collected in Antigua & Barbuda is plotted on the left axis from 2006 – 2016.

4.3 Environmental and Social Performance

The boundary levels used within this analysis were adopted from Jia et al., 2019 where the ecological planetary boundaries were broken down by per capita rates by O'Neil et al. (2018). CO₂ calculations were based on the Paris Agreement's goal of limiting global warming to 2°C. However, the freshwater availability threshold was assessed specifically through the scope of small island developing states (UN-OHRLLS.,2015). For the remaining social outcomes, the threshold values were more subjective but adequately reflects the requirements needed for meeting the basic needs of living a “healthy life” from a global perspective (O'Neil et al., 2018).

From an environmental perspective Antigua & Barbuda's ecological footprint measured in global hectares per capita indicates that the country is utilizing 2.5 times more the resources and waste than the Earth can regenerate. The ecological footprint decreased 9% between 2006 and 2013 and increased 10% from 2013-2016. The average carbon dioxide emissions for Antigua & Barbuda is three-fold higher than the boundary level required for limiting the world's global warming to 2°C. The carbon dioxide emissions increased 11% from 2006-2010 and decreased 3% from 2010 to 2014. From a social perspective education and life expectancy were two social outcomes successfully achieved. Life expectancy increased 2% between 2006 and 2017, while secondary enrollment decreased 8% from 2008 to 2012 but remained within the threshold value. Nutrition and freshwater availability were the two remaining social outcomes that were not achieved with nutrition falling 3% less than the boundary level and the access to fresh water available estimated at 39% less than the boundary level, classifying Antigua & Barbuda within the water scarcity category amongst SIDS.

Antigua & Barbuda's environmental performance was analyzed through the use of two environmental metrics; where the performance ratio greater than 1 (highlighted in yellow) indicates that the country has exceeded the boundary level. Social performance was analyzed based on three social metrics, where a ratio greater than 1 indicates that the country has achieve the respective social outcome compared to a ratio measuring less than 1, indicating that the country has failed to achieve the social outcome (as highlighted in yellow).

Table 9: An evaluation of Antigua & Barbuda's social and ecological performance

	Planetary Boundary Level (cap/yr)	Antigua & Barbuda's Performance (capita/yr)	Performance Ratio (Antigua & Barbuda's Performance/ Planetary's Boundary Value)
CO ₂ Emission	1.61t	5.1 t	3.17
Ecological Footprint	1.71 gha	4.3 gha	2.53
Social Indicators			
Social Indicators	Global Threshold Value	Antigua & Barbuda's Performance	Performance Ratio (Antigua & Barbuda's Performance/Global Threshold Value)
Education	95%	111%	1.17
Nutrition	2,700 calories	2,619	0.97
Life Expectancy	65 years	67 years	1.03
Fresh Water Availability	1000 m ³	610 m ³	0.61

4.4 Material Intensity Typologies and Height Assumption

Table 10 outlines the material intensities of the 7 different material intensity typologies examined in this study which reflects Antigua & Barbuda's local construction styles. The table outlines the different building use type classes that are categorized under each individual material typology class.

Table 10: Material Intensity Typologies for Antigua & Barbuda (kg/m²) based on local construction styles.

Construction Style	Aggregate	Wood	Concrete	Steel	Building use-type Classes
Concrete Structure 1					
Foundation Pad footing	76.24	0.91	91.48	30.5	Hotels; Rural-area single family dwelling; Urban area single family dwelling;
Foundation – Column and Beam	0	0	0	0	
Ground slab	0	0	227.27	13.79	
Floors (Suspended)	0	0	227.27	13.79	

Walls	109.95	7.73	8.98	0	Rural Residential area family dwelling; Double house family; Business and Dwelling; Townhouse;	
Roof- Frame	0	15.35	55.82	5.58		
Roof Covering	0	0	0	3.85		
Total	186.19	23.99	610.82	67.51		
Concrete Structure 2						
Foundation- Strip foundation	109.95	1.59	116.83	45.36	Churches; Schools; Hospitals; Health Clinics; Commercial; Police Stations; Fire Station; Government; Offices; Airport; Bus terminals; Stadium; Sports Complex; Rural-area single family dwelling; Urban area single family dwelling; Rural Residential area family dwelling; Double house family; Business and Dwelling; Townhouse	
Foundation – Concrete Blocks	0	0	8.98	0		
Ground Slab	0	0	227.27	13.79		
Floors (Suspended)	0	0	227.27	13.79		
Walls	109.95	7.73	8.98	0		
Roof-frame	0	15.35	55.82	5.58		
Roof-Covering	0	0	0	3.85		
Total	219.9	24.67	645.15	82.37		
Concrete Structure 3						
Foundation -Pile	0	1.17	152.61	30.1		Rural-area single family dwelling; Urban area single family dwelling; Rural Residential area family dwelling; Double house family; Business and Dwelling; Townhouse
Foundation – Pile Cap and Beam	0	0	0	0		
Ground Slab	0	0	227.27	13.79		
Floors (Suspended)	0	0	227.27	13.79		
Walls	109.95	7.73	8.98	0		
Roof-frame	0	15.35	55.82	5.58		
Roof -Covering	0	0	0	3.85		
Total	109.95	24.25	671.95	67.11		
Timber						
Foundation – Strip foundation/Concrete Pillars	109.95	1.59	117.44	45.36	Business & Dwelling Mixed Use. Rural-area single family dwelling; Urban area single family dwelling; Rural Residential area family dwelling; Double house family; Business and Dwelling; Townhouse	
Floors	0	4.62	0	0		
Walls	0	6.15	0	0		
Roof-Frame	0	15.35	0	0.77		
Roof-Covering	0	0	0	3.85		
Total	109.95	27.71	117.44	49.98		
Concrete/Timber Mix Structure						
Foundation- Strip foundation	109.95	1.59	116.83	45.36	Rural-area single family dwelling; Urban area single family dwelling; Rural Residential area family dwelling; Double house family; Business and Dwelling;	
Foundation – Concrete Blocks	0	0	2.97	0		
Ground Slab	0	0	115.38	6.15		
Floors	0	0	115.38	6.15		

Walls	111.65	3.92	2.97	0	Townhouse
Roof-frame	0	15.35	55.82	5.58	
Roof-Covering	0	0	0	3.85	
Total	221.6	20.86	409.35	67.09	
Cut-stone Historical Buildings					
Foundation – strip footing	109.95	1.59	116.83	45.36	Historical Buildings; Cathedral
Ground slab – Concrete	0	0	227.27	13.79	
Floors (Suspended)	0	0	0	0	
Walls- Cut stone and concrete	0	0	0	0	
Roof frame – timbre	0	15.35	55.82	5.58	
Roof Covering galvanize	0	0	0	3.85	
Total	109.95	16.94	399.92	68.58	
Reinforced Concrete Structure					
Foundation -strip footing	109.95	1.59	116.83	45.36	
Ground Slab	0	0	227.27	13.79	
Floors (suspended)	0	0	227.27	13.79	
Walls	109.95	7.73	8.98	0	
Roof- Frame	0	15.82	55.82	5.58	
Roof – Covering	0	0	0	3.85	
Total	219.9	25.14	636.17	82.37	
Steel Structure					
Foundation – Column Beam and Foundation Pad	76.24	0.91	91.48	30.5	Industrial; Seaport; Industrial
Floor Slab	0	0	0	0	
Walls- Concrete Block Walls	0	0	0	0	
Roof Covering – Galvanize sheeting and steel	0	0	0	0	
Roof Frame – Steel	0	0	0	0	
Roof Covering	0	0	0	3.85	
Total	76.24	0.91	91.48	34.35	

4.5 Residential Material Intensity and Height Assumptions

Material intensities are expressed as the weight of construction material measured in kilograms per gross floor area (GFA) (kg/m^2). The GFA constitutes the area and the the number of stories (height measurements), where these two parameters reflect the material composition and the size of buildings in the country, which are required components in estimating the building

material stock (Mesta et al. 2017). Therefore, assessing the uncertainties within these two criteria are vital to consider in the material stock estimate.

Figure 25 illustrates the results yielding from the Monte Carlo simulation focused on investigating the extent to which the residential material stock estimates can vary based on randomly assigning the material typologies for this building use-type class. The residential building-use type class has a significant impact on the total material stock estimate for the island, due to the fact that the residential class occupies 90% of the building footprints in Antigua & Barbuda for 2004.

The code was applied under seven different parameters, with the number of iterations ranging between 10 to 20,000. Figure 25 shows the greatest variation within the total material stock after running 10 iterations in comparison to running 20,000 iterations. The uncertainty within the upper and lower levels decrease, as the number of iterations increases. This indicates that as the number of iterations increase, the more likely the mean estimates of the material stock falls within a narrower range (smaller margin of error). The population mean of the residential material stock approaches a more stable rate after 5,000 iterations.

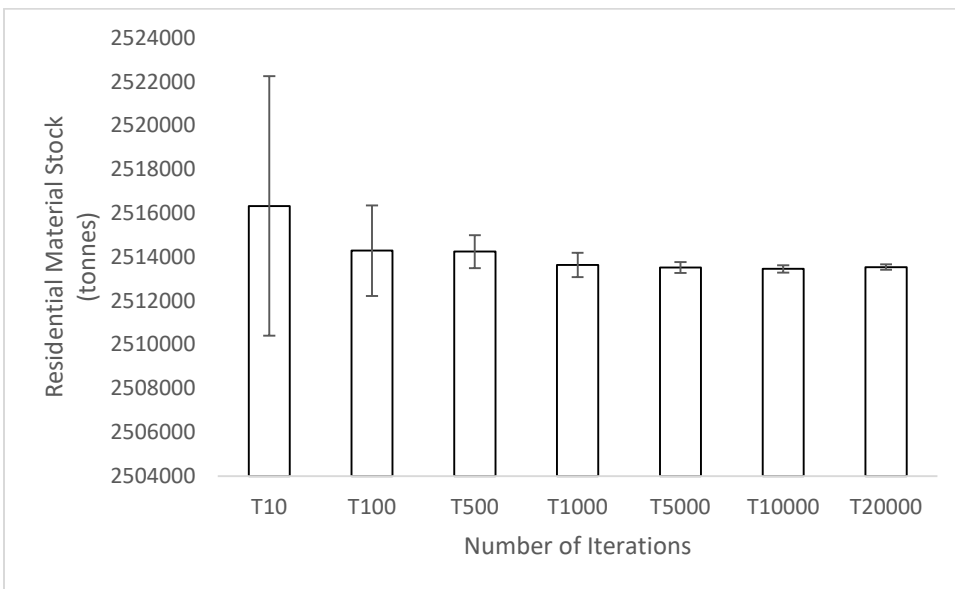

Figure 25: The confidence intervals centered around the population mean for randomly assigning the material typologies within the residential building use-type class through the Monte Carlo simulation.

In Table 11 it shows the percentage change observed in the total material stock as result of a (+/-) floor change in each building use-type class. The greatest material stock changes are

observed within residential family dwellings at 84%, rural family dwellings (45%), and large-scale hotels at 43%. The sensitivity analysis shows that inaccurately assigning the number of floors to each building use-type category can have a significant impact on the material stock estimate. The use of actual height measurements would reflect a more accurate estimate. The results test the assumptions of the role that height data plays within the MSA and illustrate where possible improvement in the methodology can be considered in future research.

Table 11: The percentage change in the total estimated material stock for each building-use type under a (+/-) floor change

Building Code	Building Typology-1,2 & 3 (Class, Groups & Subgroups)	Original Number of Floors Estimation	Percentage Change (%) in Total MS
110	Church	1	2.47%
111	Cathedral	2	0.14%
120	Government Offices	2	4.73%
130	School	2	13.49%
141	Hospitals	3	2.82%
142	Health Clinics	1	0.71%
151	Police Station Military	2	4.69%
160	Fire Station	2	0.21%
210	Bus station	1	0.02%
220	Seaport	2	0.06%
230	Airport	2	2.70%
310	Large-scale multi building hotels	3	42.51%
320	Small-scale villas and condos	2	22.77%
330	Tours & Excursion	1	0.07%
400	Protected Areas	1	0.45%
510	Restaurant/Fast Food	1	0.82%
520	Bank	2	0.09%
530	Businesses	1	9.75%
540	Shopping Mall/Complex	1	2.15%
550	Commercial Mix Use	2	31.98%
610	Community Centre	1	0.12%
620	Stadium	2	0.16%
630	Sports Complex	1	0.11%
640	Entertainment	3	0.06%
701	Museum	2	0.27%
702	Historical Landmarks	1	0.50%
810	Rural area single family dwelling	1	45.37%
820	Urban area single family dwelling	1	3.42%
830	Residential are single dwelling area	2	84.37%

840	Townhouse	1	0.003%
850	Business & Dwelling	2	0.53%
900	Industrial	1	0.60%

4.6 Material Stock (MS) of Buildings

In 2004, the total material stock for buildings in Antigua & Barbuda was calculated at 4,698 kilotons, which is equivalent to 58.5 t/cap. In Figure 26, concrete accounts for more than half the total material stock in buildings at 62%. After concrete, aggregates consume the second largest amount of materials at 25%, followed by steel and timber with 9% and 4% respectively.

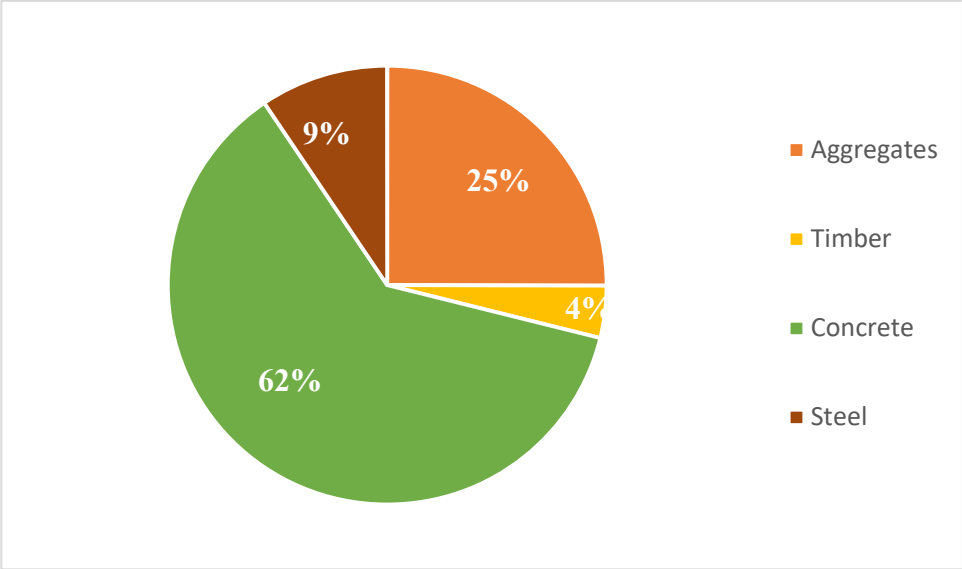

Figure 26: Breakdown of the total estimated MS (4,698 kilotons) by material category in Antigua & Barbuda for 2004.

4.6.1 *Material Stock Divided by Building Use-Type*

In Figure 27, the residential building class dominated the total MS accounting for 2,476 kt totaling to 53% of the total MS. Tourism and commercial building classes represented the second largest amount of the MS, accounting for 18% and 17% of the total MS respectively.

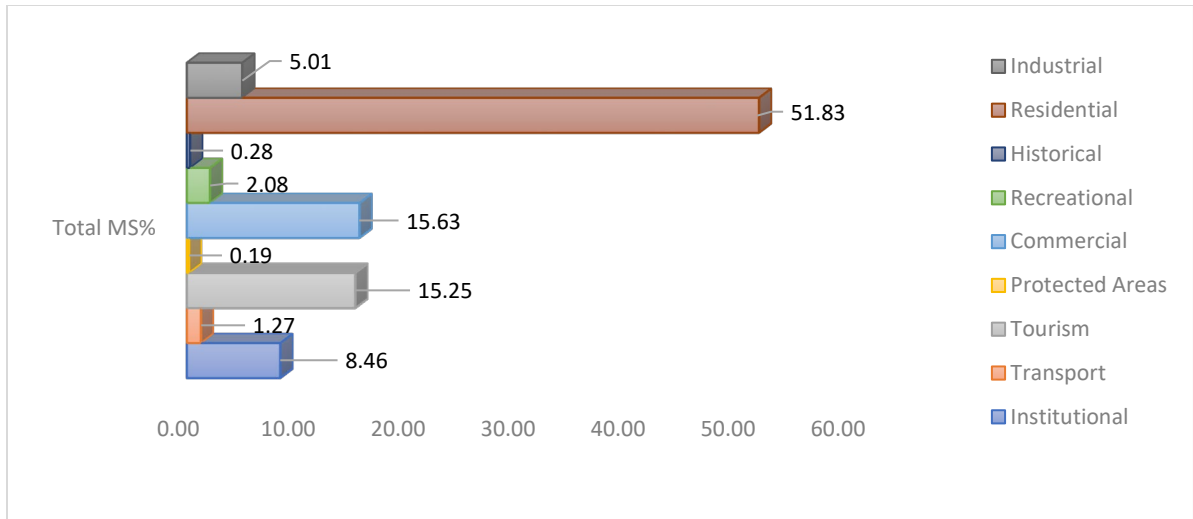

Figure 27: The total percentage of the building material stock separated by building use-type categories in Antigua & Barbuda for 2004.

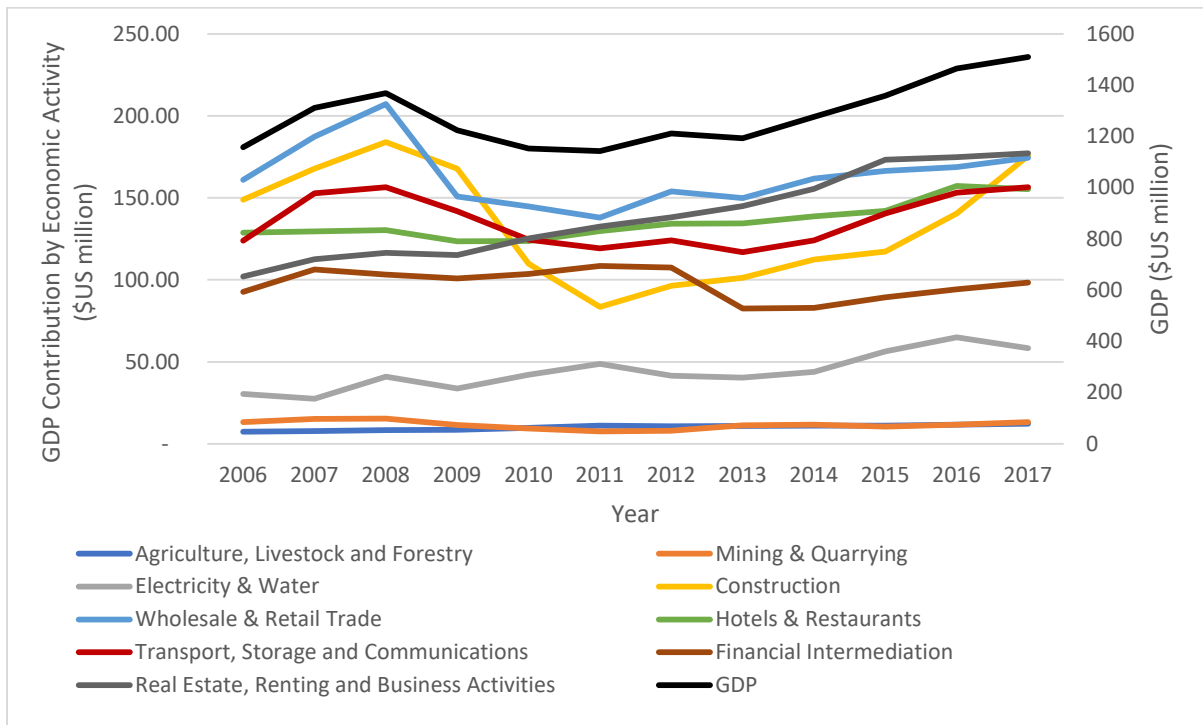

Figure 28: GDP contribution broken down by economic activity plotted on the left (primary) axis and GDP values plotted on the right (secondary) axis in Antigua & Barbuda from 2006-2017.

In Figure 28 highlights the top 10 economic activities in Antigua & Barbuda which are mainly service based. “Electricity and Water” and “Real estate, renting and business activities” shows the greatest growth within the 11-year period increasing 91% and 74 % respectively. The

construction industry suffered a great loss during 2008 and 2011 with a decrease of 45% in economic activity and increased 75% from 83 million USD in 2011 to 176 million USD in 2017.

Table 12 shows the per capita values of the construction materials within the building-use type categories. The residential building class accounts for the highest tonnes per capita at 30.8 tonnes per capita.

Table 12: Building material stock per capita, broken down by the building use types and material category. Units t/cap

Building use-type Categories	Aggregate (t/cap)	Timber (t/cap)	Concrete (t/cap)	Steel (t/cap)
Institutional	1.330	1.330	3.901	0.058
Transport	0.001	0.014	0.358	0.047
Hotels/Tourism	2.237	0.288	7.337	0.811
Commercial	2.255	0.253	6.619	0.845
Sports & Recreation	0.029	0.001	0.051	0.012
Historical Sites & Protected Areas	0.078	0.175	0.074	0.003
Residential	8.521	1.366	17.645	3.273
Industrial	0.065	2.265	0.078	0.029

In Figure 29, the highest percentage share of concrete was seen in Tourism at 69%, indicating it as a heavily reliant concrete industry as opposed to Industrial buildings which are the most steel intensive building use-type category and historical buildings which are more timber intensive building use-type.

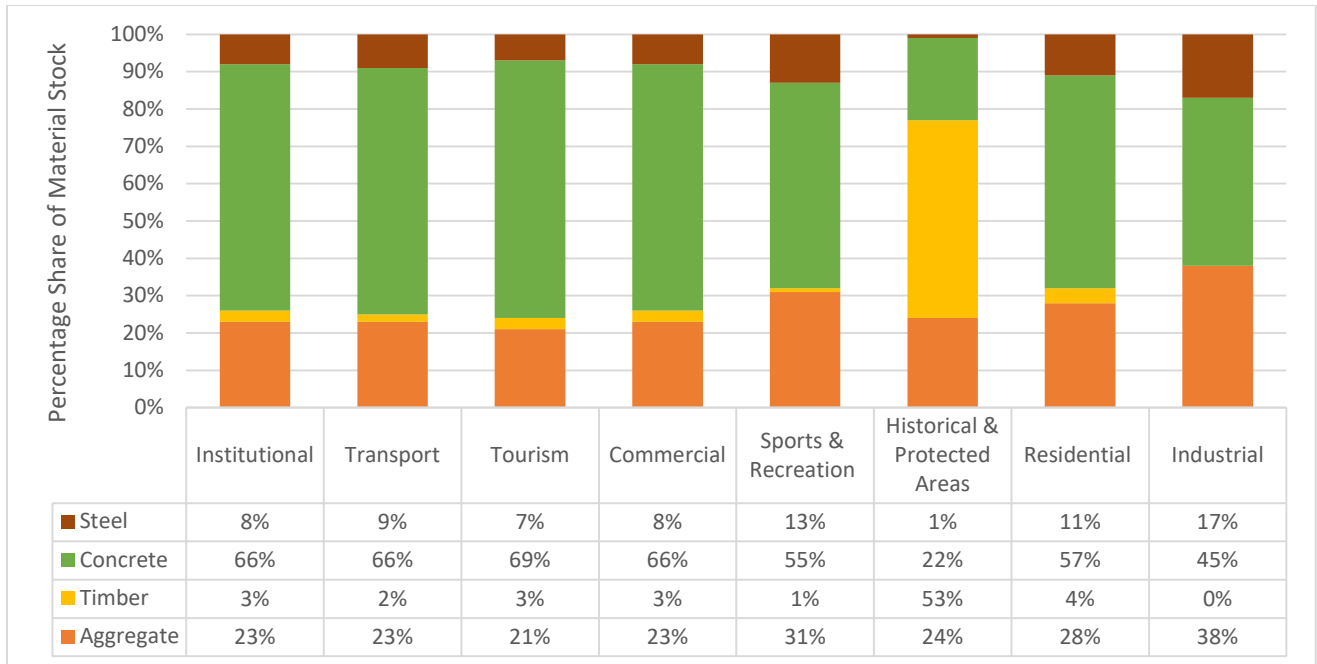

Figure 29: Building Material Stock broken down by material category (percentage%) in Antigua & Barbuda for 2004.

4.6.2 Spatial Distribution

The spatial distribution of material stock for the Antigua is presented in Figure 30 on a national scale and in Figure 31, on a local scale. Figure 30 shows the density of the total material stock through dividing the island into 100m² cells. This facilitated in the successful mapping of the accumulation of MS across the island. The densest pools of material stocks are represented by a dark yellow to a burnt orange-reddish colour, and the green colours are representative of the low accumulation of material stocks. The hotspots of building MS are located mostly around the coast as opposed to being located inwards, away from the coastline. St. John’s city the main commercial district, and the primary port of entry for both the trading of goods and cruise ship arrivals showed the highest accumulation of building MS. Other areas such as Jolly and English Harbour indicated high amounts of MS and are considered intensive tourism areas. The two locations are major tourist hubs with surrounding small scale and large-scale hotels and restaurants located around the area’s perimeter.

Figure 31 breaks down the individual material's contribution to the total MS. The total amount of concrete, steel, timber, and aggregates are measured in tonnes and are all represented for a small subsection within the parish of St. John's. Figure 31 shows aggregates and steel are more densely occupied within buildings in comparison to concrete and timber. However concrete and timber are greater in quantity and are higher in mass with greater intensities (NB: the difference in scales). As a result, spatial analysis on a local scale allows for a more in-depth analysis on the distribution and the intensity of materials occupying the building MS in Antigua & Barbuda compared to spatial distribution of MS on the national scale.

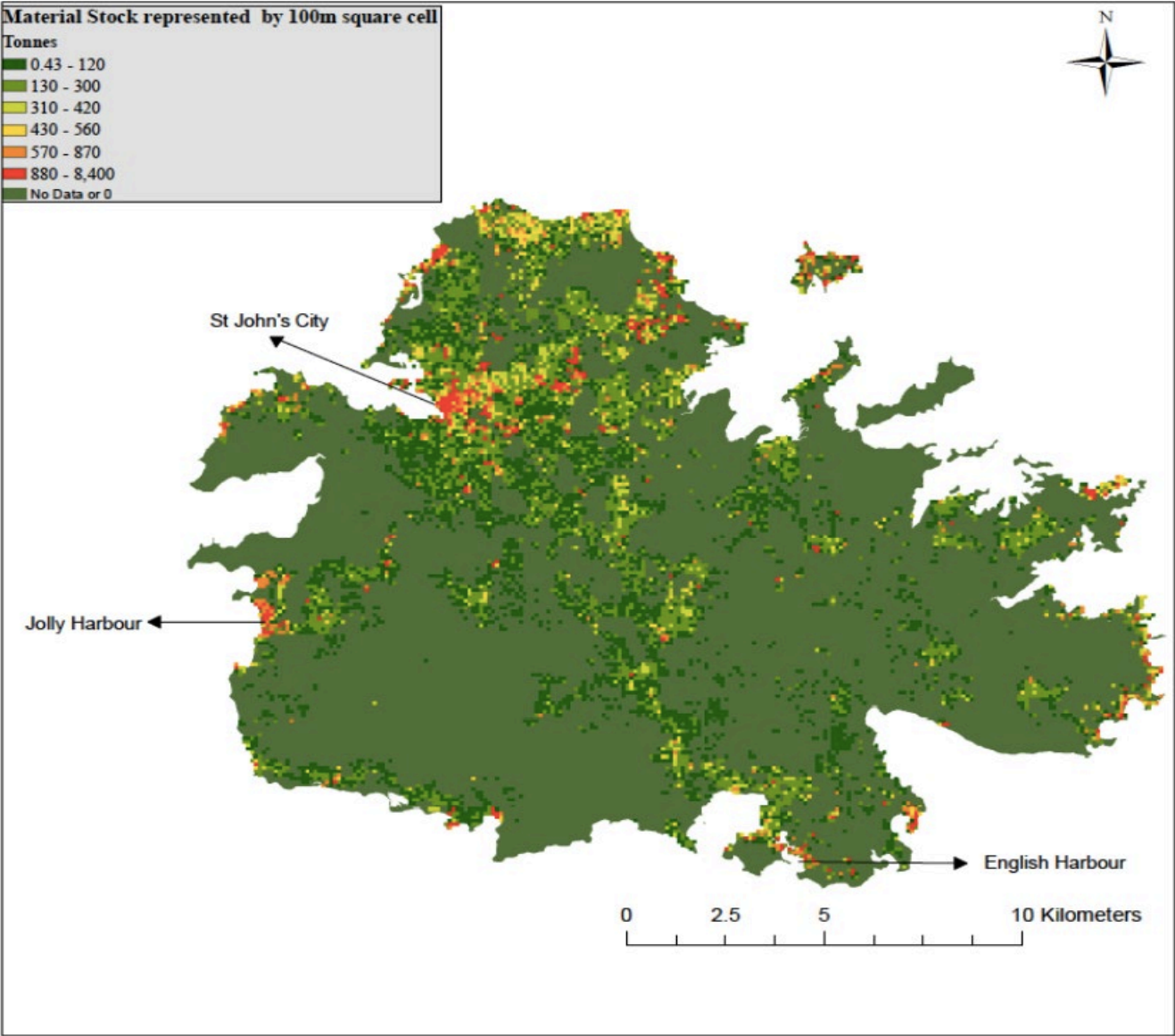

Figure 30: The spatial distribution of the total material stock (MS) of construction materials within buildings in Antigua & Barbuda (2004).



A.



B.

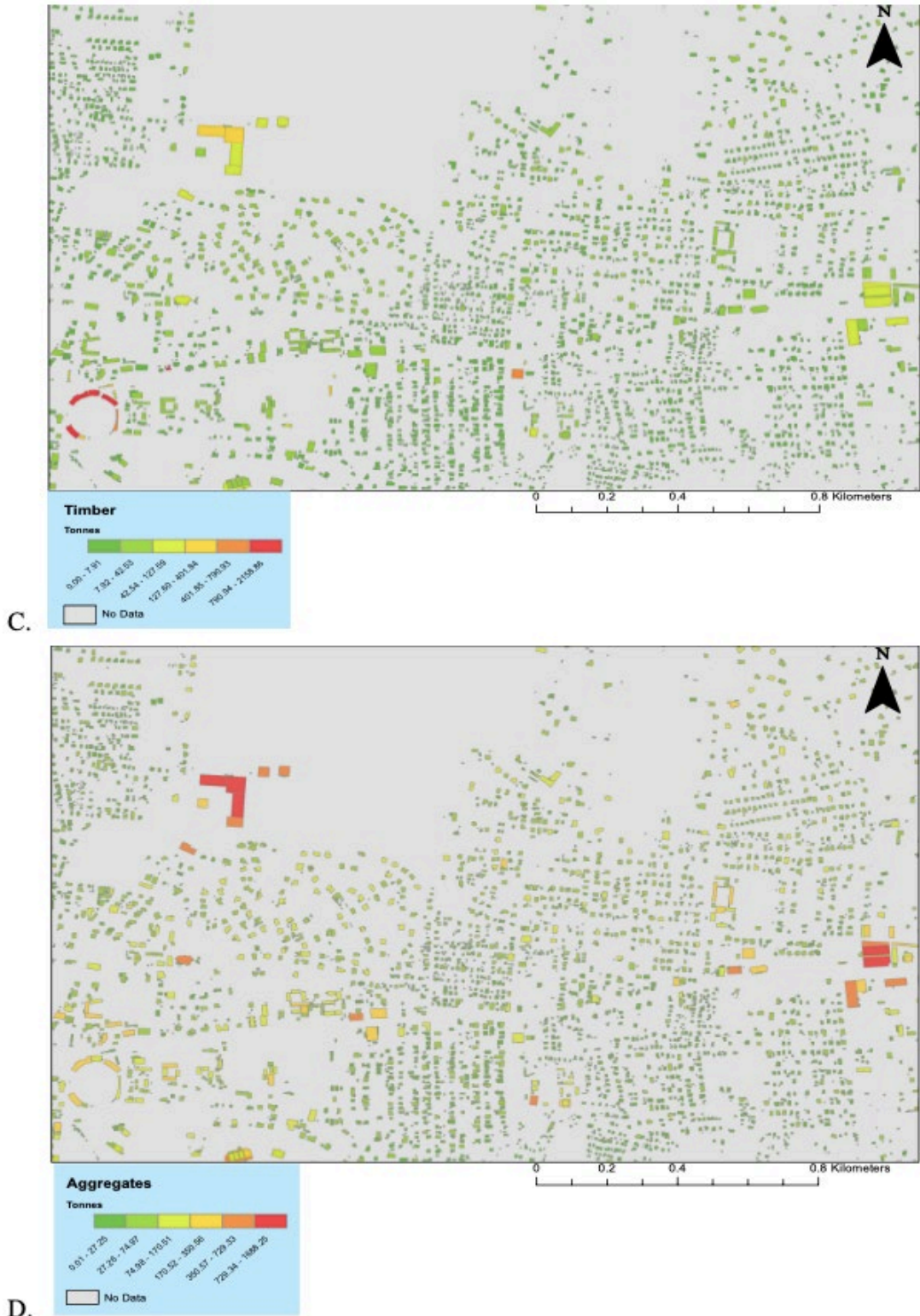

Figure 31: A local-scale distribution of the total amount of concrete(A), steel (B), timber (C) and aggregates (D) respectively within buildings (measured in tonnes) situated in the capital of the country, St. John's.

4.7 Material Stock Vulnerability: Flood Risk Map & Sea Level Rise (SLR)

This section examines vulnerability of the island’s material stock based on a simplified flood risk map and a sea level rise analysis with their results summarized in Table 9 and 10 respectively.

4.7.1 *Flood Risk Map.*

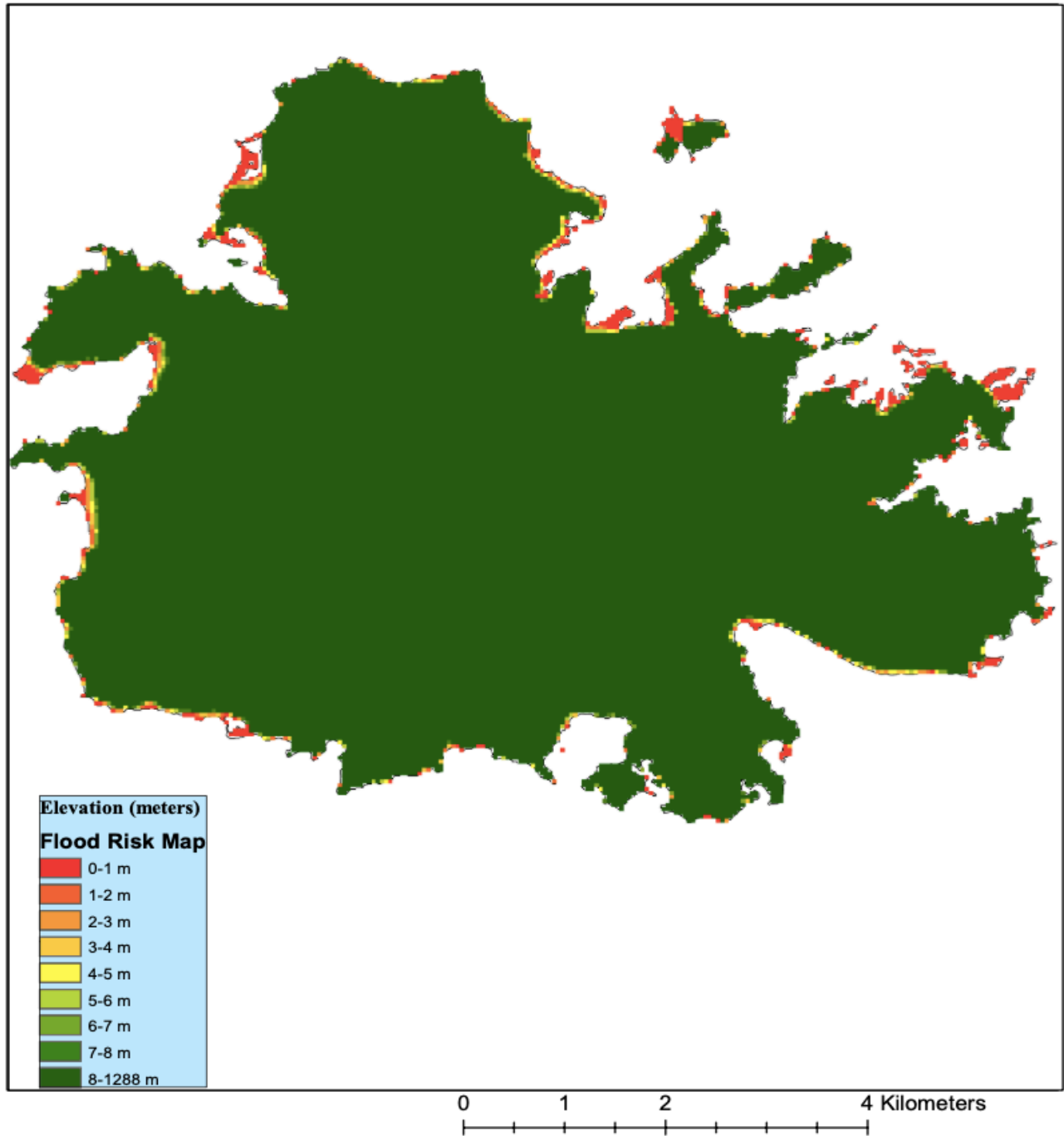

Figure: 32 A flood risk map of Antigua & Barbuda identifying coastal areas on the island that are potentially exposed to different levels of flooding based strictly on elevation data.

In Figure 32 shows various areas on the island that are threatened by inland flooding that can be experienced within short-term periods as a result of hurricanes, intense rainfall, and storm surges. The map shows that with an expected 1-2 m rise of water, equivalent to 3-7 ft rise of water a vast amount of land area is predicted to be impacted which are represented by the red hotspots. In table 13, approximately 976 building footprints are exposed under a 1-2 m rise in flood waters equivalent to approximately 5% of the island’s material stock. The flood risk intervals chosen above were based on storm surge values experienced within the Caribbean between 2017- 2019 during the hurricane season. Barbuda experienced inundation levels measuring at minimum of 2.5m (8ft) above ground level (Cangialosi et al., 2019). In the Grand Bahama, storm surge levels were estimate above 5.5m (18ft) – 7m (23ft) above normal tide levels (NOAA., 2019).

Table 13: Exposed Building Footprint and Material Stock (MS) based on various flood risk levels

Flood Risk Level	1 m	2 m	3 m	4 m	5 m	6 m	7m	8 m
Number of Building Footprints Impacted	790	976	1,171	1,313	1,588	1,752	2,075	2,278
Estimated MS Exposed	3.78%	4.83%	6.11%	7.13%	8.47 %	9.5%	10.91%	11.64%

4.7.2 Sea Level Rise (SLR)

The vulnerability of the building material stock in Antigua & Barbuda was assessed in terms of a sea rise level analysis. This analysis identified the number of buildings, material stock, and the respective building use-type categories that are exposed under a 2 m sea level rise scenario based on global predictions for 2100 (Parris et al. 2012). Figure 33 highlights four impacted areas on the island that would be exposed under to the projected sea level rise scenario, they include:

1. Marina & Dickenson Bay
2. St James Club
3. Jolly Harbour
4. Long Bay

In these four areas contains buildings vacation homes, resorts, and beach houses situated within close proximity of the coastal area around the island highlighted in orange.

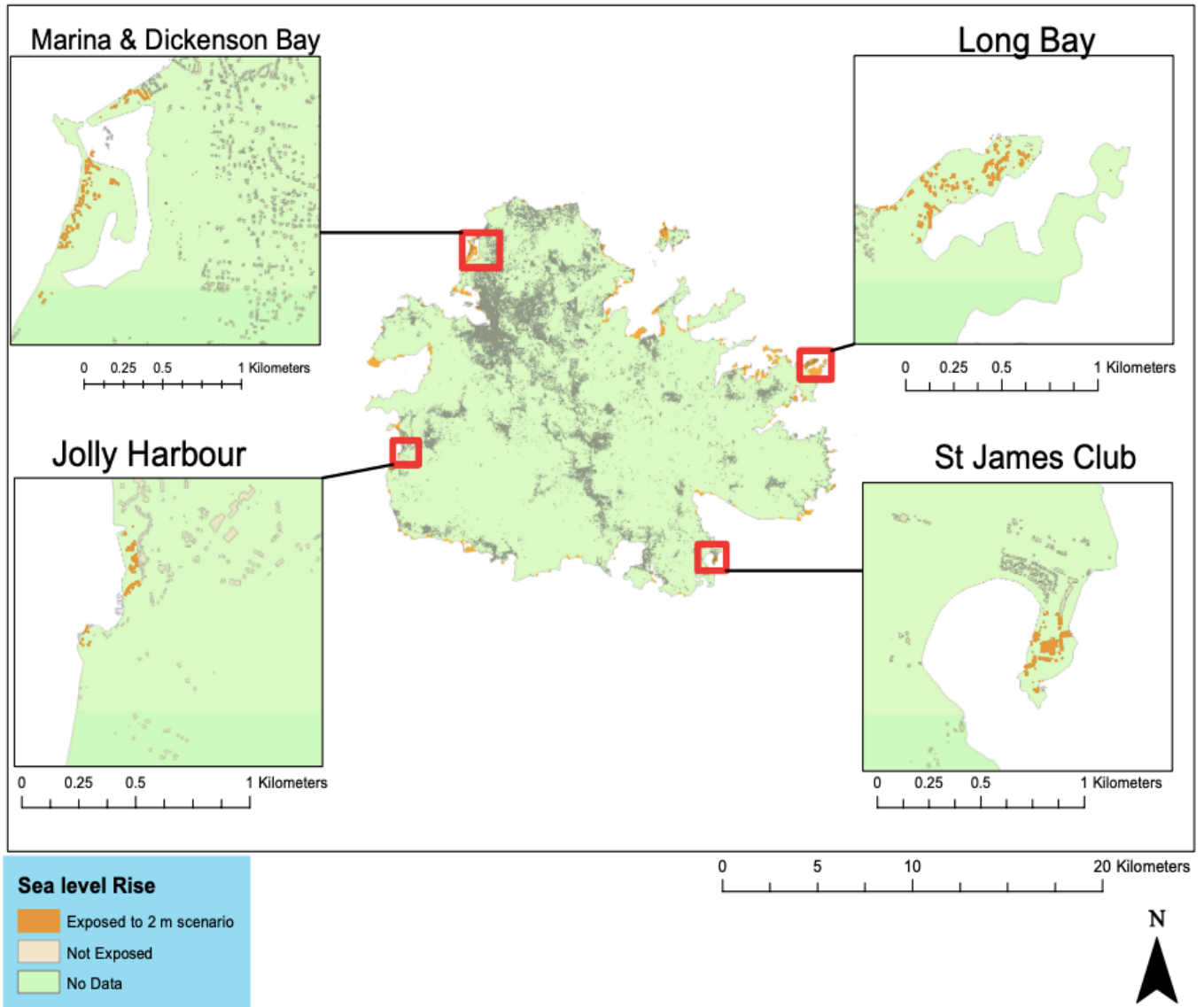

Figure 33: Four impacted areas on the island that would be exposed under a 2-meter sea level rise scenario including Marina & Dickenson Bay, St James Club, Jolly Harbour, and Long Bay. Exposed areas are highlighted in orange

Table 14 summarizes the estimated exposed material stock within the different building use-type categories. Tourism, Historical Sites and Transport based buildings were most vulnerable as they account for the highest portion of buildings exposed measuring at 18.82%, 14.47% and 14.26% respectively.

Table 14: The percentage of exposed material stock within the affected building use-type categories identified in the sea level rise analysis and flood risk assessment.

Building-use type	1m		2m	
	MS Exposed (kt)	% of Use type MS Exposed	MS Exposed (kt)	% of Use type MS Exposed
Institutional	2.99	0.63%	5.13	1.09%
Transport	7.44	17.02%	6.23	14.26%
Tourism	143.27	16.71%	161.37	18.82%
Commercial	7.72	0.96%	13.32	1.66%
Sports & Recreation	0.05	0.68%	0.05	0.68%
Historical Sites & Protected Areas	2.35	14.66%	2.32	14.47%
Residential	7.65	0.31%	9.35	0.38%
Industrial	0.05	0.36%	0.05	0.36%

Tourism was the most impacted building use-type, consisting of 69% of the total building footprint exposed, equivalent to 19% of the tourism industry’s MS and 16% of the industry’s GDP, exposed under the 2m sea level rise projections as shown in Table 14 and Figure 34. Majority of the tourism facilities in Antigua & Barbuda are situated on the coast and are directly exposed to the threat of sea level rise. Residential buildings located near the coast are also threatened and consisted of 15% of the exposed buildings. As the level of predicted sea level rise increases, the number of threatened buildings will increase, as well as the coastal services that are provided to the socio-economic system.

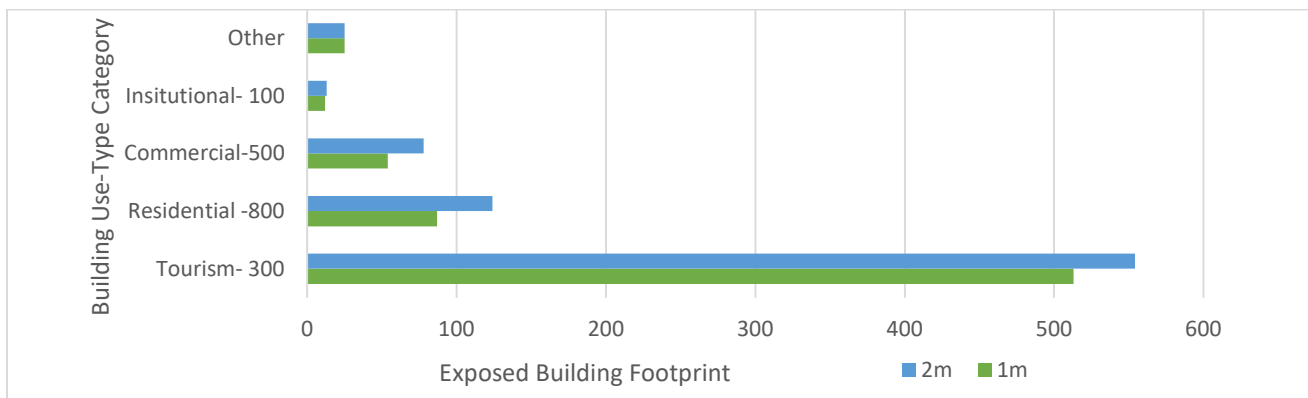

Figure 34: A breakdown of the number of exposed building footprints by their respective building use-type category in the main island of Antigua.

5 Discussion

This section discusses the findings obtained from the time series EW-MFA of construction materials in Antigua & Barbuda from 2006 to 2017 (Section 4.1). In combination with the material stock analysis of construction materials in 2004 (Section 4.6), and the vulnerability assessment of the material stock based on a sea level rise analysis (Section 4.7). Furthermore, results from the abovementioned section will be discussed to answer the main research questions governing the thesis outlined in Section 1.3. In addition to discussing the role socio-economic metabolism research can play in promoting a platform geared towards understanding island economies and achieving island sustainability. Lastly, the thesis will conclude with a brief summary of the entire research project and the importance of the research.

5.1 Antigua & Barbuda's material stocks and flows: Per capita level of Material-Use and the Physical Economy.

Antigua & Barbuda's building material stock (MS) is estimated at 4,698 kt equivalent to 58.5 t/cap in 2004. Tanikawa and Hashimoto, (2010) estimated the building MS in Wakayama, Japan and in Salford, UK in the same year measuring at 247 t/cap and 111 t/cap respectively. Recent research conducted in another Caribbean island known as Grenada, estimated MS in buildings at 11,959 kt or 112 t/cap (Symmes et al., 2019). A&B's MS in both absolute terms and per-capita rate are 60% of neighbouring Grenada. Differences between the estimated MS of the two islands can be contributed to the 10-year time difference between the material stock estimates and the local construction styles practiced in both countries that can impact material intensities. For a more accurate comparison, the accumulation of material stock during the 10-year time period would be tracked and quantified to facilitate in an adequate analysis between the two Caribbean SIDS. However, comparing the MS estimates of Wakayama and A&B in 2004, shows the differences between the MS of an urban growing city and a small island developing country, as Wakayama's MS in t/cap is four-fold greater than A&B.

Table 15: The residential building material stock of various locations in the literature

Location & Year	Residential Building Stocks (t/cap)	Source
Antigua & Barbuda (2004)	31	<i>This current study</i>
Chiclayo, Peru (2007)	47	Mesta et al., 2018

EU-25 (2009)	72	Wiedenhofer et al., 2015
Vienna (2011)	132	Kleemann et al., 2016
Grenada (2014)	70	Symmes et al., 2019

In A&B the residential building class accounts for 52% of the total MS at 31 t/cap. The residential sector plays a dominant role within the economy and within the building stock accumulation. In 2011 Vienna’s residential building sector contributed to 60% of the total mass of buildings at 132 t/cap (Kleemann et al., 2017). In 2009, Wiedenhofer et al., (2015) estimates the average residential material stock of the EU-25 at 72 t/capita, equivalent to 26% of the total physical infrastructure stock. In the city of Chiclayo, Peru, the overall MS in buildings within the residential sector was estimated at 24 Mt or 47 t/cap in 2007, based on historical data projections the MS increased 360% from 1981- 2017 within 36 years (Mesta et al., 2018). In Grenada the MS in buildings in the residential sector is estimated at 70 t/cap, accounting for 67% of MS (Symmes et al., 2019). Overall, within the three Latin American and Caribbean locations and the city of Vienna, the residential sector constitutes at least 50% of the total MS as seen in in Table 15.

In A&B, outside of the residential use-type buildings, commercial and tourism related services contribute to 30% of the building MS at 10 t/cap and 11 t/cap respectively. In Grenada tourism (15 t/cap) and commercial/industrial (13 t/cap) services contributed to 25% of the total MS, with tourism ranking as the second highest contributor after the residential sector in the two islands. Although the material stock-flow-service nexus has not been fully explored within socioeconomic metabolism research, the service compartment link can be identified as a critical driving factor for MS addition and growth within the socio-economic environment. Acknowledging that services which provides benefits to society’s well-being can only supplied through resource flows and MS (Haberl et al., 2017). In a single driven service based-economy like A&B and most other Caribbean countries, the material stock-flow-service nexus is an instrumental approach in understanding local-scale resource flows, material stock growth, and determining resource requirements for providing services. This approach can be used through the context of eco-efficiency and transformative sustainable pathway in light of achieving sustainable development goals.

In A&B based on the results yielding from the time series EW-MFA, the consumption indicator DMC illustrated an apparent decrease of metabolic rates from 2006-2017. In 2006, DMC

was measured at 8.5 t/cap/yr compared to 2017 of an estimated value of 2.6 t/cap/yr, equalling to an overall 69% decline from 2006-2017. From 1985 to 2010 the Philippines showed an increase in DMC per capita of construction materials from an estimated 3 t/cap/yr to 3.5t/cap/yr, where construction material consumption rates were increasing faster than population rates. Highlighting the role construction materials play in increasing the country's infrastructure, buildings, and supplying the material stocks to meet the growing service demand within countries (Martinico-Perez et al., 2016). In terms of a regional perspective in 2010, Latin America and the Caribbean's DMC per capita value of construction materials was estimated at 2.3 t/cap which was reportedly lower than consumption rates reported by emerging economies like Asia (Schaffartzik et al., 2014).

These low values speak towards the relatively low levels of investment into the physical infrastructure in these island states. However, in A&B, it is important to note that the apparent dematerialization experienced from 2006 to 2017 may not be as a direct result of an increase in material efficiency, but the declining levels of DMC could be a consequence of the economic downfalls experienced within this time period. In 2009 after the global economic crisis in 2008, the DMC rates A&B's experienced an 80% decrease in the time span of 3 years from 8.5 t/cap 2006 to 1.7 t/cap in 2009. This sudden decline in construction material consumption was further exacerbated by the collapse of the country's largest sole private investor (Sandford Financial Group) and the closure of Trinidad-based CL Financial Group (BBC., 2018). These series of events created a domino effect on the entire country's economic system, with thousands of people being displaced from jobs alongside the closing of local banks. Thus, forcing the country into a period of economic despair (Davis., 2012). Additionally, during this time period the price of diesel fossil fuel experienced its highest level of increases which added to the financial cost of material imports of construction materials. Similar patterns were observed in Cuba between 1993 and 2003, the country witnessed a 7% decrease in DMC while GDP grew at 40% as a result of a decline in material use consequently stemming from an economic crisis (Eisenhut., 2009).

Non-metallic minerals contribute to 62 % of the total building MS in A&B at 36 t/cap in 2004. Non-metallic minerals play an instrumental role in expanding the MS within A&B and within the construction industry. Fishman., et al. (2015) estimated the total construction MS of Japan and the United States in 2005 measured at 36 Bt of construction minerals (93% of the total MS) or 288 t/cap and 96 Bt of construction minerals (90% of the total MS), or 337.5 t/cap respectively. The trend amongst the three different countries speaks to the high mass of the non-

metallic share of minerals apart of the total MS and quantity of construction minerals required for the built infrastructure.

Domestic extractions (DE) are crucial to non-metallic minerals in particular sand and gravel. This is seen in the mass quantity of sand and gravel extracted to meet the demands of concrete production, building sub-layer and for meeting the needs of transportation networks in A&B as seen in Figures 15 and 16. DE of sand and gravel accounts for 88% of the DMC of non-metallic minerals in A&B from 2006-2017. Globally, Miatto et al. (2016) estimated in 2010 that sand and gravel constituted the main share of non-metallic minerals at approximately 72%, with a per capita value of 5t, falling within close range of A&B's average DE value of sand and gravel estimated at 3.0 t/cap from 2006-2017. Symmes et al. (2019) reported Grenada's average DE of 3.8 t/cap from 1993-2009, which was in close proximity of A&B's estimated value. In comparison to the wider Latin America and Caribbean region, A&B and Grenada's average DE per capita rates falls above the region's value measured at 0.5 t/cap (Schaffartzik et al., 2014).

The greatest addition to stock in the EW-MFA time series was witnessed between the beginning two years of the 2006-2017 time period. GAS per capita were estimated at 8.5 t/cap in 2006 and 6.0 t/cap in 2007. A&B's best economic performance was reported in 2006, where GDP increased by 12% compared to the 5% growth reported in the prior year. The 2006 growth in GDP was attributed to other sectors in the economy including wholesale and retail trade, construction, transport, storage and communications, and hotels and restaurants. The exceptionally high rates of GAS in 2006 and 2007 can be attributed to multiple developmental projects initiated in the twin island state within the two-year gap led by private investments (IMF., 2006). This includes the Sir Vivian Richards Stadium was built during the previous years in preparation to host the 2007 Cricket World Cup Stadium which caters to a capacity of 20,000 people with four towers. In addition to the 4-story modern Mount St. John's Medical centre that was under construction; and now serves as the country's only public hospital which was established in the subsequent year in 2008. The large amount of construction materials required to meet these major construction projects can be linked to the high rates of GAS in 2006 and 2007. In 2007, the residential sq. ft. and the amount of C&D waste were at its peak throughout the 11-year period. These trends could be attributed to two housing developments initiated in 2006 (North Sound Housing and Lightfoot No.6). In addition to the abovementioned developments, the peak in 2007 within C&D waste could also be connected to the planned hotel expansion, renovation, and new construction projects

planned to be completed by year's end in 2006. The tourism boom was marked with 40 new tourism construction developments and renovations all to be completed in the next five years with an estimated total of \$1.4 billion dollars (Kephart, 2006). GAS spiked in two years, including 2011 and 2013. The 2011 spike was followed by the passing of Hurricane Earl in 2010 which caused flooding as a result of high waves and storm surges within low-lying areas on the A&B, causing damages to buildings and homes. A&B experienced major damage estimated at 12.5 million USD (Cangialosi, 2011). The growth spurt in material inflows and GAS the following year can be linked to material needed to repair damages. The 2013 growth spike coincides to the construction of the country's (2,300 m²) public library estimated cost of 3.46 million USD which would require large quantities of construction materials to complete the project.

GDP experienced fluctuations with periods of highs and lows within the 11-year time period. A&B's economic growth occurs in "spurts" with the previous growth spurt occurring in 2003 and after 2007 (UNEP, 2011b). However, unlike the trends seen as a result of the material flow analysis of construction materials consumption in Section 4.1 (Imports, PTB, DMC, DE, Exports, GAS and NAS), GDP showed an overall increasing trend while material inflows, outflows and material accumulation declined. To put this into perspective, the total dollar value of all goods produced in A&B from 2006-2017, through GDP suggest there was a 30% increase in comparison to a 73% decline of GAS observed in A&B within the same time period. However, economic and material use appears to be influenced by GDP, as market prices appears to impact the quantity of material consumption (DMC) and material productivity (GDP/DMC), more specifically non-metallic minerals as seen in Figures 11 and 18. Therefore, as GDP increases, both DMC and non-metallic mineral imports decreases and vice versa. This pattern was not noticed within the remaining categories of construction materials, however since non-metallic minerals contributed to the predominant share of total imports, this trend was reflected within the DMC. A possible explanation to this trend is that there may be a time lapse between investment and construction activity, where construction may take place 6-12 months after receiving funding for investments.

To further analyze these trends, GDP was separated into the individual classes of economic activities contributing to local economy's growth (Figure 28). In 2006 and 2007, A&B witnessed the highest growth levels of GAS during 2006–2007, during these two years construction activity was the second largest economic contributor to A&B's economy accounting for 12.8% of the GDP

in 2007. However, between 2008 and 2011 construction activity sharply declined measuring at 7.3% in 2011, the construction boom was projected to “wind down” in 2007 – 2008 (IMF., 2006). Based on the construction industry’s GDP contribution to local economy, the construction boom downfall extended from 2008-2011 as seen in Figure 28. This extended period was further exasperated by the global and economic crisis in 2008 triggering declining tourism and foreign direct investments (FDI) based construction activities (IMF., 2010). During this period material flows including DMC per capita rates declined 68%, and GAS declined 30%. However, after 2011 the GDP contribution of construction material increased two-fold from 2011 to 2017, but material consumption (DMC) showed an overall decline.

The analysis of building applications and C&D waste provide an additional lens in understanding the physical flows of construction materials in Antigua & Barbuda. They provide a broad overview of the amount of construction taking place annually with the country’s boundary. Trends observed within the building applications and C&D waste showed a similar trend as observed in the MFA, where there was of an overall decline in the building applications and the C&D waste from 2006-2017. C&D waste quantities describes the potential of greater resource-use initiatives tailored towards material recycle. In Antigua & Barbuda, there are currently no waste management and recycling framework available for this category of waste on the island.

A&B illustrates from a small island developing state context, the extent of vulnerability and sensitivity within the physical economy in response to both external and internal changes faced by the country. In combination with a growing small population, single major events such as the construction of a new hospital, stadiums, hotel developments and change in government can cause spikes in national material consumption. Consequently, events such as the downfall of one private investor or company, an international financial crisis, and extreme weather events can be reflected in the country’s material consumption and level of economic activity.

5.2 Spatial distribution of the building stock- The importance of building resilience

In mapping the spatial distribution of MS in A&B, spatial patterns show the main hotspots of MS are situated within close proximity of the island’s coast. The capital, St John’s shows a high MS accumulation within its core. This location also hosts one of the island’s central business hubs, in addition to accommodating the passage of all the cruise ships docking in the island. The main seaport is also located within the central city where all materials and goods enter and leave the country via sea vessel. The high accumulation of MS with St. John’s city can be connected to the

many services that are provided by the built environment within the city core. Thus, building upon the material stock -flow-service nexus briefly mentioned in Section 1.2.

The outskirts of the city core is surrounded by a growing urban residential area where a smaller quantity of MS can be found. Residential development has favoured the northern side of the island where pockets of medium-high MS are distributed, as well as the airport. MS is present within low-medium levels in the middle of the island where primary and secondary roads are used to travel to the south end of the island. This type of development is referred to as ribbon development. According to Davies (as cited in Cohen, 1995), ribbon developments are “beaded clusters of activities strung out alongside major roads... that may contain a high incidence of services and sometimes a mixture of small wholesale and manufacturing establishments” (p. 226). As seen in Figure 31, this ribbon development is connected to other residential areas within villages on the southern side on the island. Here, other secondary hotspots of MS can be found, such as one of the main tourist hubs on the island, English Harbour. Beach resorts and other tourism related facilities which are located on the western side of the island where medium to high levels of MS have accumulated. Other MS hotspots located on the southern easterly quadrant of the island, corresponds with remaining tourism hubs with a vast majority of resorts and restaurants situated on the coast, including the Jolly Harbour area.

5.3 Tourism and Material Stocks

Tourism has evolved into an integral part of the socio-economic structure within SIDS, functioning as an important source of income supporting the livelihoods of the local population and the foundation of many small islands’ economic base (UN-OHRLLS., 2015). In A&B, the spatial distribution of material stocks, show growing hotspots of tourism related material stock accumulation on the coast of the island. Tourism accounts for approximately 80% of A&B’s GDP and influences the growth of other services. For example, in Jolly Harbour and English Harbour two tourism hotspots identified on the map in Figure 30 identified as "intensive tourism activity areas"; where these areas have proven to show a developmental pattern that has been economically successful for the twin island state (UNEP., 2011b). The model stimulates the growth of additional services (outside the focus of hotels and restaurants) which can be easily accessible to the temporary tourist population base such as tourist non-resident-based villas, hotels, restaurants, marinas, car rental agencies, shopping centers, and banking facilities. Weaver, (1988) explained that tourism can create spatial changes as a result of its impact on social and economic development

of the periphery. However, this developmental model warrants concern for socio-economic disparities such as restricting access to local residents to beaches located within these areas. The tourist centered areas can possibly create “islands within islands” that restrict the use of local residents within the surrounding communities. Local developmental projects must take into consideration these concerns prior future tourism related construction takes place on the island and seek to create greater inclusivity and sustainable growth within the sector.

In A&B, annual tourist arrivals include tourists arriving on different modes of transportation such as air, cruise, and yacht. The average number of tourists’ arrivals into the country is 90% greater than the islands population, measuring at 879 thousand tourists arriving per year between 2006-2017. The ratio of yearly visiting tourists in comparison to the local population size, puts into perspective the distribution of material stocks attributed to tourism development to accommodate the temporary and visiting population as opposed to the material stocks centered around local infrastructure and development within surrounding communities on the island. The country currently houses two medical schools that cater predominantly to international students that also contribute to the visiting population within Antigua & Barbuda. The dynamics between tourism and the visiting population on material stocks puts into perspective a different means to understanding material stocks-flows-service nexus.

The tourism industry is threatened by the effects of changing climate, thus reflecting the high level of vulnerability faced by the islands’ socio-economic system as a result of the industry being A&B’s main economic driver. This pattern is echoed within most SIDS in the Caribbean, where in 2012 two million people were employed within the region’s tourism sector accounting for 14% of the GDP. The impacts of climate change on tourism will be significant as a result extreme weather events, storm surges, in-land flooding, and sea level rise which will increase the environmental vulnerability faced by SIDS. Under a 1 m sea level rise scenario 29% of the major resorts within the Caribbean would be partially or fully inundated with a projected loss from the tourism sector totaling to 2,750 million USD by 2100 (UN-OHRLLS., 2015). Pang et al. (2013) argues that tourism will become a potential victim of climate change where factors such as the location destination and the country’s ability to build adaptive capacities to cope with expected changes will be key aspects to consider in increasing the sector’s resiliency. In Section 4.7.2 tourism is identified as the most vulnerable building use-type exposed under a 2 m sea rise scenario in A&B, with an estimated 18.8 % tourism’s total MS being impacted equivalent to 15% of the

island's GDP. In addition, commercial and historical building use-type categories are threatened by a 2 m sea level rise with 14% of their MS being exposed respectively. This translates into a serious problem and concern for already existing hotels, resorts, coastal homes, and local business enterprises located on beach front property and those within close proximity to the coastal region. As a result, it is vital to shift focus towards building resiliency within the sector through a biophysical, social, cultural, economically, and environmental lens, to protect and sustain the continued growth of the tourism sector within A&B.

Tourism is mainly vulnerable to disaster because it depends on infrastructure and natural ecosystem services provided by the ocean (Brown et al., 2017; Eco-union., 2019). As a result of the concentration of hotels, resorts, and population on the coast sea level rise and extreme events can result in abrupt disturbances within the tourism sector (Eco-union., 2019). To increase disaster preparedness and protect the socio-economic services provided by the tourism sector scenario planning can be considered within the sector's vitality on SIDS. Gossling and Scott., (2012) explains the development of scenario planning for sustainable tourism to assist governments and businesses in the decision making process within the sector to prepare for future uncertainties such as climate change, economic development, biodiversity and ecosystem change and other remaining factors that can adversely impact the tourism sector. Sustainable tourism incorporates other core principles such as economic viability, physical integrity, community well-being, and resource efficiency (Eco-union., 2019).

During 2006-2017, the amount of construction materials consumed decreased. Although material consumption was not separated by building-use type category or services, the trend within the building permits showed that housing permits fluctuated greatly and declined in comparison to commercial building permits which were more stable. Thus, indicating that commercial construction, by extension commercial investments remained stable in comparison to housing development which is reflective of fluctuations in social factors such as personal income, and employment. As a result of evaluating the social and environmental performance of the island, A&B exceed the two environmental indicators examined included CO₂ emissions and ecological footprint. However, the ecological footprint displayed a declining trend between 2006-2013 indicating a decrease in the amount of resources consumed per capita. From a social perspective A&B achieved two social outcomes from a total of four, including a rising healthy life expectancy indicating the local residents are living longer and healthier lives. Secondary school enrollment

experienced an 8% decline and still fell within the threshold value. Nutrition did not achieve the threshold value falling short of by 3% as the freshwater availability within the country fell within the water scarce category, with water being one of the basic needs for survival. Although GDP showed a general upward trend the social and environmental metrics indicates that there is major improvement required within the socio-environment sphere. The sensitivity of island economies shows the importance of island sustainability. Despite A&B showing an increase in material productivity and GDP, this trend is not indicative of an increase in social well-being and environmental performance.

5.4 Limitations and Future Work

The lack of data presented numerous setbacks and limited the structure, scope and level of accuracy in this research. The limitations are briefly outlined as follows:

- In Section 3.4 the classification of building footprints, the data set used is reflective of that from the physical infrastructure present in 2004. This was the most recently updated building footprint layer available to the researcher. The remote sensing component involving the use of imagery provided by online platforms such as Google Maps, which only reflected the country's current building layout for 2019. Unfortunately, the time-lapse feature was unavailable in order to view the corresponding building footprints from 2004. To improve accuracy, a recently updated building footprint layer would have been preferred to match the structures present the ground when collecting data during the field work. The use of buildings will most likely change within a 15-year period, accounting for these changes would have been beneficial for the material stock analysis. It would also provide a more accurate reflection of the country's current material stock and facilitate in a comparative study of the MS quantified from previous years, to provide a complete picture of material flows and stocks within A&B's economy. The country can benefit from frequently updating their building footprint data sets on a regular basis through long-term monitoring and assessment of changes in material use and the type of construction materials utilized within the built environment.
- In Section 3.6, actual height measurements of the buildings were absent from the data set. Height measurements play a crucial role in a material stock analysis. To increase the accuracy of the material stock analysis height measurements should be used to increase the

precision of the final MS estimate. As a substitute, the number of floors (stories) within a building was used as proxy. In Table 6, the number of floors were assigned based on the Building Typology 2 and 3 level due to wide variation of the number of floors present within the Building Typology 1 class. For example, all buildings classified under Tourism would be assigned a 2-floor height measurement. However, this number would vary based on if it is a small hotel or a large resort. Assigning the number of floors was primarily based on the representative set of buildings which were visited during fieldwork. However, the majority of these buildings were residential and commercial buildings. Therefore, additional field work would be required to get a representative set for the number of floors within each building use-type category. As a recommendation the government should invest in collecting more geo-spatial and remote sensing data as it can be beneficial to the growing economy in many ways, including disaster management and spatial planning of future developments.

- Trade data provided by the Statistician Division in A&B represents data collected and summarized separately by other departments within the government. However, the data collected within these ministries need to ensure that there is a high level of accuracy and a formal data collection procedure to validate data prior being given to the Statistician Division. In other terms the government should implement a standardize procedure for data verification and certification for all government ministries to follow. This will be beneficial in preventing inconsistencies such as missing trade data for the entire year of 2008 in A&B and to buffer against typos when copying/typing numerical values. There is an urgency for an overall improvement in the quality of data collection and management in A&B. This includes domestic extractions, especially the amount of sand extracted from sand mining within Barbuda on a yearly basis, more details on commercial development such as hotels (including the year built, the size of each hotel, the number of rooms offered by each hotel etc.) More attention should be given to the collection of different types of data in the country including Lidar elevation data which can be used to attain accurate height measurement of buildings and used to provide up-to-date, and high resolution elevation data that can be utilized within modeling the coastal environment to improve sea level rise analysis and identifying vulnerable areas (Gesch., 2009). This will lead to more capacity

building initiatives to illustrate specific needs of critical areas such as climate finance to the international organizations.

- Roads were excluded from the scope of this research limiting the MS estimate from reflecting A&B's entire built environment. However, roads are treated differently in comparison to buildings which are more distinct structures. Roads are viewed as “networks of continuous structures” undergoing constant growth and modifications (Tanikawa et al., 2015). The contribution to roads should not be overlooked seeing that they are the main medium through which mobility is provided and is major a component of the transportation network. Transitioning towards more sustainable infrastructure and development, roads are critical component as it provides the social system with greater access to services and facilitate in the movement of goods and people as previously described with ribbon development. Through a material stock perspective, roads have a shorter service life and stocking age compared to buildings, warranting for greater maintenance and replacement (Schiller., 2007). In terms of material consumption, choosing which type of road to build (concrete, paved, bitumen unsurfaced (sand and gravel mix) would relate their associated expected lifetime impacts and the frequency at which roads would be maintained or replaced. This is an important aspect in minimizing resource use and determining which type of road is more sustainable. Nguyen, Fishman, Miatto, and Tanikawa (2018) expressed that there is a lack of attention being paid to resource dynamics of the transport infrastructure development. This is important, especially through the lens of climate change, when faced with decisions on repairing damages post disaster.
- In terms of further research, this study has the potential to narrow its scope and direct focus on assessing the vulnerability of material stocks against extreme weather events through the eye of the storm. The foundation of the research will remain the same, building upon an EW-MFA framework and a material stock analysis. However, vulnerability will be assessed on the historical trends of hurricanes and their pathway through the island. Output from this analysis will map hurricane pathways and spatially assess vulnerable areas on the island, through the estimated loss of MS and characterizing the type of material loss and establishing safe building zones or identifying more vulnerable areas to evacuate during hurricanes or flooding. Recovered materials can have potential in being downcycled or reused within the physical environment. This type of research can assist in quantifying and

classifying debris post extreme event thus, strengthening SIDS disaster risk management framework amidst the growing threats of climate hazards amongst the vulnerable group of islands. In terms of the methodological approach, there is room to further test the assumptions made and to improve on critical areas such as the height measurements and the material intensities.

6 Conclusion

This study adds to a growing area of research specifically focused on the dynamics of material stocks and flows within islands. The complex relationship between the two addresses the following:

- The way in which material consumption fluctuates and responds to both internal and external events that impact the socio-economic system.
- The extent of vulnerability faced by A&B through the context of economic and environmental factors.
- The dynamics between economic growth (GDP) compared to social and environmental performances- where trends between the two factors may differ relating to the island's sustainable progress.

A&B's material flow analysis indicated an overall decline in their domestic material consumption of construction materials during 2006-2017. However, during this period of decreased material consumption, economic activity continued to grow as gross domestic product showed an upward trend, accompanied by increased material productivity and tourist arrivals. Although economic activity showed positive growth, it does not necessarily express social performance and well-being within the island.

Islands including A&B have significantly capitalized on their service-based tourism fueled economy. The material stock analysis showed that the second highest share of material stock following after residential buildings was tourism in 2004. The growth of the tourism industry in A&B is intensive and has dominated the coastal development on the island. Tourism has influenced the growth of services around major tourism hotspots which primarily caters to a select group of people who temporarily stay within the island. The growth periods observed within the economy are catalyzed by increased periods of investment mainly driven by the tourism industry (UNEP, 2011b). Tourist arrivals between 2006-2017 were on average 90% greater than the entire population of Antigua & Barbuda. As a result, much of the material stocks and infrastructure development is devoted to the temporary tourist population in comparison to the local population. This presents a different perspective to understanding the stocks-flows-service nexus. The relationship between material stocks growth in A&B also puts into the perspective the economic and environmental vulnerability the twin island state faces; as tourism experiences the greatest

exposure of its sector's material stock under a 2 m sea level rise scenario. An estimated 19% of the tourism material stock is threatened which is equivalent to 15% of the small island state's GDP.

Can the island's economy be sustainable with tourism as its main economic driver? What social and economic impacts would a decline in tourism have on the island? Based on the points raised within this thesis, it illustrates the importance and potential of using the material stock-flow-service nexus as an approach to better understand island economies and achieving island sustainability. A shift of focus is required to the type of services driving material stock growth within the island, to better illustrate how the interrelationship between stocks, flows, and services can be adjusted to foster sustainable growth.

From an environmental perspective, SIDS are threatened by extreme weather events and natural hazards with heightened risk faced by climate change. The Caribbean Group for Cooperation in Economic Development (2002) explains that natural disasters are inherently a developmental issue whereby after a disaster has occurred there is evidence as to why investment and unsustainable planning decisions can function as a contributing factor to vulnerability, thus causing further damage. The cost of inaction amongst SIDS is greater than any cost of damage incurred by a hurricane. The call for action is now, and the use of material stock flow accounts and spatial analysis provide significant information on MS pertaining to disaster risk which policy makers should implement within these SIDS, especially A&B. Information originating from the material stock flow analysis can be used as a useful tool to implement effective management of risk reduction and function as a steppingstone towards increased long-term resiliency.

Disaster risk reduction frameworks, such as the Sendai Framework is built on four pillars that material stock and flow accounts can contribute to, including: understanding disaster risk, strengthening disaster risk governance, investing and enhancing in disaster risk reduction (ECLAC, 2019). On a local scale, the tool can be applied to inform government officials and policy makers on the necessary steps that need to be taken to adapt and cope with disasters such as flooding, storm surges, and sea level rise through transitioning to more climate resilient systems and promoting sustainable growth within the physical infrastructure and across sectors within the economy. The use of GIS and spatial data integrated into the application of material stock flow accounts creates a functional tool linking location to information which is a key feature of decision making within local communities and sensitive island economies. This can be incorporated into building back better and stronger, aiding in recovery, planning, and reconstruction with the focus

to minimize future risk, after witnessing the damages occurring in Barbuda during the 2017 Atlantic Season.

The methodological contribution of the study is highlighted through exploring the assumptions based on the original methodology proposed by Symmes et al., (2019). This included illustrating the impact of accurately assigning the material intensity typologies to their respective building use-type category. As seen in the Monte Carlo simulation through distributing the material typologies within the residential class, it shows a high level of uncertainty within the random assignment of material typologies in 10 iterations as opposed to 5000 iterations, only after which the material stock estimates approached a stable rate as uncertainties within the estimates were minimal. The sensitivity analysis of the height data showed that height measurements had a strong impact on the total material estimates based on absolute change of 1 in the number of floors resulting in changes in the material stock of over 80%. Greater improvements in the material stock analysis methodology would be seen with the use of actual building height measurements of the researcher's study area. To maximize on the accuracy of future material stock estimates, further research should focus on continuing to improve this methodology so it can be easily applied within other SIDS as seen in Grenada and now Antigua & Barbuda.

7 Bibliography

- Akadiri, P. O., Chinyio, E. A., & Olomolaiye, P. O. (2012). Design of A Sustainable Building: A Conceptual Framework for Implementing Sustainability in the Building Sector. *Buildings*, 2(2), 126-152. doi:10.3390/buildings2020126
- Akenji, L., & Bengtsson, M. (2014). Making Sustainable Consumption and Production the Core of Sustainable Development Goals. *Sustainability*, 6(2), 513-529. doi:10.3390/su6020513
- Ali, A., (2018, June 18). Antigua and Barbuda: Destined for climate finance success. The Commonwealth. Retrieved from <https://thecommonwealth.org/media/news/antigua-and-barbuda-destined-climate-finance-success>
- Anderberg, S. (1997). Material flow Analysis and Sustainable Development. *Journal of Social Sciences*, 1(3), 187-200. doi:10.1080/09718923.1997.11892175
- Augiseau, V., & Barles, S. (2017). Studying construction materials flows and stock: A review. *Resources, Conservation and Recycling*, 123, 153-164.
- Bahaire, T., & Elliott-White, M. (1999). The Application of Geographical Information Systems (GIS) in Sustainable Tourism Planning: A Review. *Journal of Sustainable Tourism*, 7(2), 159–174. doi: 10.1080/09669589908667333
- Baynes, T. M., & Müller, D. B. (2016). A socio-economic metabolism approach to sustainable development and climate change mitigation. In *Taking stock of industrial ecology* (pp. 117-135). Springer, Cham.
- Bateman, I. J., Jones, A. P., Lovett, A. A., Lake, I. R., & Day, B. H. (2002). Applying geographical information systems (GIS) to environmental and resource economics. *Environmental and Resource Economics*, 22(1-2), 219-269.
- BBC, (2018, March 12). Antigua and Barbuda profile – Timeline. *BBC News* <https://www.bbc.com/news/world-latin-america-18707512>
- Bergsdal, H., Bohne, R. A., & Brattebø, H. (2007). Projection of construction and demolition waste in Norway. *Journal of Industrial Ecology*, 11(3), 27-39.
- Brown, N. A., Rovins, J. E., Feldmann-Jensen, S., Orchiston, C., & Johnston, D. (2017). Exploring disaster resilience within the hotel sector: A systematic review of literature. *International Journal of Disaster Risk Reduction*, 22, 362-370.
- Camacho-Otero, J., Boks, C., & Pettersen, I. (2018). Consumption in the circular economy: A literature review. *Sustainability*, 10(8), 2758

- Campbell, J.(2009) Islandness: vulnerability and resilience in Oceania. *Shima Int J Res Isl Cultures* 3(1):85–97.
- Cangialosi, J, P., Latto, A, S., & Berg, R., (2018). National hurricane Center Tropical Cyclone Report-Hurricane Irma. Retrieved from https://www.nhc.noaa.gov/data/tcr/AL112017_Irma.pdf
- Caribbean Disaster Emergency Management Agency CDEMA. (2014). Regional Comprehensive Disaster Management. Retrieved from <https://www.cdema.org/CDMStrategy2014-2024.pdf>
- Centre for Research on the Epidemiology of Disasters CRED (2018). Economic Losses, Poverty, & Disasters 1998-2017. Retrieved from <https://www.unisdr.org/we/inform/publications/61119>
- Cheng, K. L., Hsu, S. C., Li, W. M., & Ma, H. W. (2018). Quantifying potential anthropogenic resources of buildings through hot spot analysis. *Resources, Conservation and Recycling*, 133, 10-20.
- Cohen, E. (1995). Touristic craft ribbon development in Thailand. *Tourism management*, 16(3), 225-235.
- Condeixa, K., Haddad, A., & Boer, D. (2017). Material flow analysis of the residential building stock at the city of Rio de Janeiro. *Journal of Cleaner Production*, 149, 1249-1267.
- Daú, G., Scavarda, A., Scavarda, L. F., & Portugal, V. J. T. (2019). The Healthcare Sustainable Supply Chain 4.0: The Circular Economy Transition Conceptual Framework with the Corporate Social Responsibility Mirror. *Sustainability*, 11(12), 3259.
- Davis, N. (2012, March 8). Allen Stanford: Antigua feels the fallout of the Ponzi case. *BBC News*. Retrieved from <https://www.bbc.com/news/business-17298267>
- Deschenes, P. J., & Chertow, M. (2004). An island approach to industrial ecology: Towards sustainability in the island context. *Journal of Environmental Planning and Management*, 47(2), 201-217. doi:10.1080/0964056042000209102
- Daigo, I., Igarashi, Y., Matsuno, Y., & Adachi, Y. (2007). Accounting for steel stock in Japan. *ISIJ international*, 47(7), 1065-1069.

- Eastern Caribbean Central Bank. (2019). Real Sector Statistics-Selected Gross Domestic Product by Economic Activity in Constant Prices. <https://www.eccb-centralbank.org/statistics/gdp-datas/country-report/2>
- Economic Commission for Latin America and the Caribbean-ECLAC. (2019). Quadrennial report on regional progress and challenges in relation to 2030 Agenda for Sustainable Development in Latin America and the Caribbean.
- Eco-union, (2019). Sustainable Blue Tourism: Blue Tourism Study. Retrieved from https://www.iddri.org/sites/default/files/PDF/Publications/Hors%20catalogue%20Iddri/20190620_BLUE%20TOURISM%20STUDY_EN.pdf
- Eisenhut, Susanna Maria. 2009. "National Material Flow Analysis." uniwien. <http://othes.univie.ac.at/3530/>.
- ESRI, (2012). What is GIS?. <https://www.esri.com/library/bestpractices/what-is-gis.pdf>.
- Eurostat, (2001). Economy-wide material flow accounts and derived indicators –A methodological guide. <https://ec.europa.eu/eurostat/documents/1798247/6191533/3-Economy-wide-material-flow-accounts...-A-methodological-guide-2001-edition.pdf/>
- Eurostat, 2013. "Economy-Wide Material Flow Accounts (EW-MFA) Compilation Guide 2013." <http://ec.europa.eu/eurostat/web/environment/methodology>
- Eurostat, (2018a). Economy-wide material flow accounts Handbook. <https://ec.europa.eu/eurostat/web/products-manuals-and-guidelines/-/KS-GQ-18-006>
- Eurostat, (2018b). -Environmental accounts-establishing the links between the environment and the economy. <https://ec.europa.eu/eurostat/statistics-explained/pdfscache/25771.pdf>
- Fischer-Kowalski, M. (1998). Society's metabolism: the intellectual history of materials flow analysis, Part I, 1860–1970. *Journal of industrial ecology*, 2(1), 61-78.
- Fischer-Kowalski, M., & Weisz, H. (1999). Society as hybrid between material and symbolic realms: Toward a theoretical framework of society-nature interaction. *Advances in human ecology*, 8, 215-252.
- Fischer-Kowalski, M., Krausmann, F., Giljum, S., Lutter, S., Mayer, A., Bringezu, S., ... Weisz, H. (2011). Methodology and Indicators of Economy-wide Material Flow Accounting. *Journal of Industrial Ecology*, 15(6), 855–876. doi: 10.1111/j.1530-9290.2011.00366.x

- Fishman, T., Schandl, H., Tanikawa, H., Walker, P., & Krausmann, F. (2014). Accounting for the material stock of nations. *Journal of Industrial Ecology*, 18(3), 407-420.
- Fishman, T., Schandl, H., & Tanikawa, H. (2015). The socio-economic drivers of material stock accumulation in Japan's prefectures. *Ecological Economics*, 113, 76-84.
- Geissdoerfer, M., Savaget, P., Bocken, N. M., & Hultink, E. J. (2017). The Circular Economy—A new sustainability paradigm?. *Journal of cleaner production*, 143, 757-768.
- Gesch, D. B. (2009). Analysis of lidar elevation data for improved identification and delineation of lands vulnerable to sea-level rise. *Journal of Coastal Research*, 49-58.
- Gössling, S., Scott, D. (2012) Scenario Planning for Sustainable Tourism: An Introduction. *Journal of Sustainable Tourism*, 20 (6), 773-778.
- Graedel, T. E., & Lifset, R. J. (2016). Industrial ecology's first decade. In *Taking Stock of Industrial Ecology* (pp. 3-20). Springer, Cham.
- Green Climate Fund. (2017). Resilience to hurricanes, floods and droughts in the building sector in Antigua and Barbuda.
https://www.greenclimate.fund/documents/20182/893456/17880_-_Resilience_to_hurricanes_floods_and_droughts_in_the_building_sector_in_Antigua_and_Barbuda.pdf/6024818c-8aae-46d1-95ec-27a000f8f2ae
- Haberl, H., Fischer-Kowalski, M., Krausmann, F., Weisz, H., & Winiwarter, V. (2004). Progress towards sustainability? What the conceptual framework of material and energy flow accounting (MEFA) can offer. *Land use policy*, 21(3), 199-213.
- Haberl, H., Wiedenhofer, D., Erb, K. H., Görg, C., & Krausmann, F. (2017). The material stock–flow–service nexus: A new approach for tackling the decoupling conundrum. *Sustainability*, 9(7), 1049.doi.org/10.3390/su9071049
- Haberl, H., Wiedenhofer, D., Pauliuk, S., Krausmann, F., Müller, D. B., & Fischer-Kowalski, M. (2019). Contributions of sociometabolic research to sustainability science. *Nature Sustainability*, 1.
- Hashimoto, S., Tanikawa, H., & Moriguchi, Y. (2007). Where will large amounts of materials accumulated within the economy go? – A material flow analysis of construction minerals for Japan. *Waste Management*, 27(12), 1725–1738. doi: 10.1016/j.wasman.2006.10.009
- Heeren, N., & Fishman, T. (2019). A database seed for a community-driven material intensity research platform. *Scientific data*, 6(1), 23.

- Heeren, N., & Hellweg, S. (2018). Tracking Construction Material over Space and Time: Prospective and Geo-referenced Modeling of Building Stocks and Construction Material Flows. *Journal of Industrial Ecology*, 23(1), 253-267. doi:10.1111/jieec.12739
- Hirato, T., Daigo, I., Matsuno, Y., & Adachi, Y. (2009). In-use stock of steel estimated by top-down approach and bottom-up approach. *ISIJ international*, 49(12), 1967-1971.
- Hu, M., Voet, E. V. D., & Huppes, G. (2010). Dynamic Material Flow Analysis for Strategic Construction and Demolition Waste Management in Beijing. *Journal of Industrial Ecology*, 14(3), 440–456. doi: 10.1111/j.1530-9290.2010.00245.x
- Hurlimann, A. C., & March, A. P. (2012). The role of spatial planning in adapting to climate change. *Wiley Interdisciplinary Reviews: Climate Change*, 3(5), 477–488. doi: 10.1002/wcc.183
- INDDEX Project, (2018).Data4Diets: Building Blocks for Diet-related Food Security Analysis. Tufts University, Boston, MA. <https://inddex.nutrition.tufts.edu/data4diets>.
- IMF, (2006). Antigua & Barbuda Staff Report for the 2006 Article IV Consultation. Retrieved from http://ctrc.sice.oas.org/trc/Articles/Antigua/IMF_ART_IV_2006.pdf
- IMF, (2010). Staff Report for the 2010 Article IV Consultation and Request for Stand-By Arrangement. Retrieved from <https://www.imf.org/external/pubs/ft/scr/2010/cr10279.pdf>
- Isernia, R., Passaro, R., Quinto, I., & Thomas, A. (2019). The Reverse Supply Chain of the E-Waste Management Processes in a Circular Economy Framework: Evidence from Italy. *Sustainability*, 11(8), 2430.
- Jia, W. (2019). Can the Caribbean Live within the Doughnut? Environmental and Social Performance of Five Island Nations(Master's thesis, University of Waterloo).
- Kaufman, S. (2012). Quantifying sustainability: Industrial ecology, materials flow and life cycle analysis. *Metropolitan Sustainability*, 40-54. doi:10.1533/9780857096463.1.40
- Kephart, M, (2006, August 31) Antigua and Barbuda Announces New Developments Worth an Estimated \$1.4 Billion. <http://www.antigua-barbuda.org/press140.htm>
- King, N, A. (2019). Sargassum Clean-up Costs Caribbean US\$120M: Bartlett. Caribbean Life News. Retrieved from <https://www.caribbeanlifeneews.com/stories/2019/8/2019-08-02-nk-sargassum-clean-up-cl.html>

- Kleemann, F., Lederer, J., Rechberger, H., & Fellner, J. (2017). GIS-based Analysis of Viennas Material Stock in Buildings. *Journal of Industrial Ecology*, 21(2), 368-380.
doi:10.1111/jiec.12446
- Korhonen, J., Honkasalo, A., & Seppälä, J. (2018). Circular economy: the concept and its limitations. *Ecological economics*, 143, 37-46.
- Kovanda, J., & Weinzettel, J. (2016). Economy-wide Material Flow Indicators on a Sectoral Level and Strategies for Decreasing Material Inputs of Sectors. *Journal of Industrial Ecology*, 21(1), 26-37. doi:10.1111/jiec.12410
- Krausmann, F., Richter, R., & Eisenmenger, N. (2014). Resource use in small island states: Material flows in Iceland and Trinidad and Tobago, 1961–2008. *Journal of industrial ecology*, 18(2), 294-305.
- Krausmann, F., Wiedenhofer, D., Lauk, C., Haas, W., Tanikawa, H., Fishman, T., . . . Haberl, H. (2017). Global socioeconomic material stocks rise 23-fold over the 20th century and require half of annual resource use. *Proceedings of the National Academy of Sciences*, 114(8), 1880-1885. doi:10.1073/pnas.1613773114
- Kumar, N., Yamaç, S. S., & Velmurugan, A. (2015). Applications of Remote Sensing and GIS in Natural Resource Management. *Journal of the Andaman Science Association Vol*, 20(1), 1-6.
- Kytzia, S. (2004). Material Flow Analysis as a Tool for Sustainable Management of the Built Environment. *The Real and Virtual Worlds of Spatial Planning*, 281-298.
doi:10.1007/978-3-662-10398-2_19
- Leising, E., Quist, J., & Bocken, N. (2018). Circular Economy in the building sector: Three cases and a collaboration tool. *Journal of Cleaner production*, 176, 976-989.
- Lichter, M., & Felsenstein, D. (2012). Assessing the costs of sea-level rise and extreme flooding at the local level: a GIS-based approach. *Ocean & coastal management*, 59, 47-62.
- Liu, Y., Chen, W. Q., Lin, T., & Gao, L. (2019). How Spatial Analysis Can Help Enhance Material Stocks and Flows Analysis?. *Resources*, 8(1), 46.
- Lwin, C. M., Hashimoto, S., & Tanikawa, H. Comparing Gross and Net Additions to Material Stock for Roadways in Japan.

- Martinico-Perez, M. F. G., Fishman, T., Okuoka, K., & Tanikawa, H. (2017). Material flow accounts and driving factors of economic growth in the Philippines. *Journal of Industrial Ecology*, 21(5), 1226-1236.
- Matthews, E., Amann, C., Bringezu, S., Fischer-Kowalski, M., Hüttler, W., Kleijn, R., ... & Schandl, H. (2000). The weight of nations. *Material Outflows from Industrial Economies*. Washington, DC: World Resources Institute.
- Mayer, A., Haas, W., Wiedenhofer, D., Krausmann, F., Nuss, P., & Blengini, G. A. (2018). Measuring Progress towards a Circular Economy: A Monitoring Framework for Economy-wide Material Loop Closing in the EU28. *Journal of Industrial Ecology*, 23(1), 62–76. doi: 10.1111/jiec.12809
- Mesta, C., Kahhat, R., & Santa-Cruz, S. (2019). Geospatial characterization of material stock in the residential Sector of a Latin-American City. *Journal of Industrial Ecology*, 23(1), 280-291.
- Mesta, C., Kahhat, R., & Santa-Cruz, S., (2017). Quantification of Lost Material Stock of Buildings After An Earthquake. A Case Study of Chicalayo, Peru. Presented at 16th World Conference on Earthquake. Santiago Chile 2017.
- Miatto, Alessio, Heinz Schandl, Tomer Fishman, and Hiroki Tanikawa. 2016. “Global Patterns and Trends for Non-Metallic Minerals Used for Construction: Global Non-Metallic Minerals Account.” *Journal of Industrial Ecology* 21 (4): 924–37. <https://doi.org/10.1111/jiec.12471>
- Mirza, M. (2003). Climate change and extreme weather events: Can developing countries adapt? *Climate Policy*, 3(3), 233-248. doi:10.1016/s1469-3062(03)00052-4
- Müller, D. B., Wang, T., & Duval, B. (2010). Patterns of iron use in societal evolution.
- Müller, E., Hilty, L. M., Widmer, R., Schlupe, M., & Faulstich, M. (2014). Modeling metal stocks and flows: a review of dynamic material flow analysis methods. *Environmental science & technology*, 48(4), 2102-2113.
- Mycoo, M. A. (2018). Beyond 1.5 C: vulnerabilities and adaptation strategies for Caribbean Small Island developing states. *Regional environmental change*, 18(8), 2341-2353.
- National Hurricane Center. (2019). Hurricane Dorian Tropical Cyclone Update. Retrieved from <https://www.nhc.noaa.gov/archive/2019/al05/al052019.update.09021255.shtml?>

- National Hurricane Center. (2011). Tropical Cyclone Report: Hurricane Earl. Cangialosi, P. J. Retrieved from https://www.nhc.noaa.gov/data/tcr/AL072010_Earl.pdf
- National Office of Disaster Service-NODS (2019). Hazards-Hurricane. Retrieved from <http://nods.gov.ag/hazzards/hurricane/>
- Nguyen, T. C., Fishman, T., Miatto, A., & Tanikawa, H. (2019). Estimating the material stock of roads: the vietnamese case study. *Journal of Industrial Ecology*, 23(3), 663-673.
- Noll, D., Wiedenhofer, D., Miatto, A., & Singh, S. J. (2019). The expansion of the built environment, waste generation and EU recycling targets on Samothraki, Greece: An island's dilemma. *Resources, Conservation and Recycling*, 150, 104405. doi: 10.1016/j.resconrec.2019.104405
- OECD. (2008a). Measuring Material Flows and Resource Productivity. Volume I-The OECD Guide. <https://www.oecd.org/environment/indicators-modelling-outlooks/MFA-Guide.pdf>
- OECD. (2008b). Measuring Material Flows and Resource Productivity. Volume II-The Accounting Framework. <https://www.oecd.org/env/indicators-modelling-outlooks/MFA-Accounting-Framework.pdf>
- Okoli, A., (2016). "Socioeconomic Metabolism of Biomass in Jamaica in the Context of Trade and National Food Security: A Time Series Biophysical Analysis (1961-2013)." <https://uwspace.uwaterloo.ca/handle/10012/11086>.
- O'Neill, D. W., Fanning, A. L., Lamb, W. F., & Steinberger, J. K. (2018). A good life for all within planetary boundaries. *Nature Sustainability*, 1(2), 88.
- Pang, S. F., McKercher, B., & Prideaux, B. (2013). Climate change and tourism: An overview. *Asia Pacific Journal of Tourism Research*, 18(1-2), 4-20.
- Parris, A., Bromirski, P., Burkett, V., Cayan, D., Culver, M., Hall, J., Horton, R., Knuuti, K., Moss, R., Obeysekera, J., Sallenger, A., & Weiss, J. (2012). Global Sea Level Rise Scenarios for the US National Climate Assessment. NOAA Tech Memo OAR CPO-1. http://cpo.noaa.gov/sites/cpo/Reports/2012/NOAA_SLR_r3.pdf
- Pauliuk, S., Wang, T., & Müller, D. B. (2013). Steel all over the world: Estimating in-use stocks of iron for 200 countries. *Resources, Conservation and Recycling*, 71, 22-30

- Pauliuk, S., & Müller, D. B. (2014). The role of in-use stocks in the social metabolism and in climate change mitigation. *Global Environmental Change*, 24, 132-142.
doi:10.1016/j.gloenvcha.2013.11.006
- Pauliuk, S., & Hertwich, E. G. (2015a). Socioeconomic metabolism as paradigm for studying the biophysical basis of human societies. *Ecological Economics*, 119, 83-93.
- Pauliuk, S., Majeau-Bettez, G., & Müller, D. B. (2015b). A General System Structure and Accounting Framework for Socioeconomic Metabolism. *Journal of Industrial Ecology*, 19(5), 728-741. doi:10.1111/jiec.12306
- Pelling, M., & Uitto, J. I. (2001). Small island developing states: Natural disaster vulnerability and global change. *Environmental Hazards*, 3(2), 49-62. doi:10.3763/ehaz.2001.0306
- Petridis, P., & Fischer-Kowalski, M. (2016). Island sustainability: The case of Samothraki. In *Social ecology* (pp. 543-557). Springer, Cham.
- Pincetl, S. (2012). A living city: Using urban metabolism analysis to view cities as life forms. *Metropolitan Sustainability*, 3-25. doi:10.1533/9780857096463.1.3
- Pomponi, F., & Moncaster, A. (2017). Circular economy for the built environment: A research framework. *Journal of Cleaner Production*, 143, 710-718.
- Poulter, B., & Halpin, P. N. (2008). Raster modelling of coastal flooding from sea-level rise. *International Journal of Geographical Information Science*, 22(2), 167-182.
- Raworth, K. A. (2012). *Safe and Just Space for Humanity: Can We Live Within the Doughnut?* Oxfam, Oxford, UK, <https://www.oxfam.org/sites/www.oxfam.org/files/dp-a-safe-and-just-space-for-humanity-130212-en.pdf>
- Rockström, J., Steffen, W., Noone, K., Persson, Å., Chapin III, F. S., Lambin, E. F., ... & Nykvist, B. (2009). A safe operating space for humanity. *Nature*, 461(7263), 472.
- Sartori, I., Bergsdal, H., Müller, D. B., & Brattebø, H. (2008). Towards modelling of construction, renovation and demolition activities: Norway's dwelling stock, 1900–2100. *Building Research & Information*, 36(5), 412-425.
- Schiller, G. (2007). Urban infrastructure: challenges for resource efficiency in the building stock. *Building Research & Information*, 35(4), 399-411.
- SEEA. (2019). *Global Economy Wide Material Flow Accounting*. Retrieved from <https://seea.un.org/content/global-consultation-global-economy-wide-material-flow-accounting-manual>

- Sev, A. (2009). How can the construction industry contribute to sustainable development? A conceptual framework. *Sustainable Development*, 17(3), 161-173.
- Statistics Division. (2001). Population and Housing Census.
https://ab.gov.ag/pdf/statistics_reports/complete_census_summary_report.pdf
- Schaffartzik, A., Mayer, A., Gingrich, S., Eisenmenger, N., Loy, C., & Krausmann, F. (2014). The global metabolic transition: Regional patterns and trends of global material flows, 1950–2010. *Global Environmental Change*, 26, 87-97.
- Schandl, H., Fischer-Kowalski, M., West, J., Giljum, S., Dittrich, M., Eisenmenger, N., ... & Krausmann, F. (2018). Global material flows and resource productivity: forty years of evidence. *Journal of Industrial Ecology*, 22(4), 827-838.
- Simpson, M.C., Scott, D., Harrison, M., Sim, R., Sliver, N., O’Keeffe, E., Harrison, S., ... & McSharry, P.(2010).Quantification and Magnitude of Losses and Damages Resulting from the Impacts of Climate Change: Modelling the Transformational Impacts and Cost of Sea Level Rise in the Caribbean (Key Points and Summary for Policy Makers Document), United Nations Development Programme (UNDP), Barbados, West Indies.
- Singh, S. J., Grünbühel, C. M., Schandl, H., & Schulz, N. (2001). Social metabolism and labour in a local context: changing environmental relations on Trinket Island. *Population and Environment*, 23(1), 71-104.
- Singh, S. J., & Haas, W. (2016). Complex Disasters on the Nicobar Islands. *Social Ecology*, 523–542. doi: 10.1007/978-3-319-33326-7_27
- Sjöstedt, M., & Povitkina, M. (2017). Vulnerability of Small Island Developing States to Natural Disasters: How Much Difference Can Effective Governments Make?. *The Journal of Environment & Development*, 26(1), 82-105.
- Symmes, R., Fishman, T., Telesford, J. N., Singh, S. J., Tan, S., & Kroon, K. (2019). The weight of islands: Leveraging Grenadas material stocks to adapt to climate change. *Journal of Industrial Ecology*. doi:10.1111/jiec.12853
- Tanikawa, H., & Hashimoto, S. (2009). Urban stock over time: spatial material stock analysis using 4d-GIS. *Building Research & Information*, 37(5-6), 483-502.
- Tanikawa, H., Managi, S., & Lwin, C. M. (2014). Estimates of lost material stock of buildings and roads due to the Great East Japan Earthquake and tsunami. *Journal of Industrial Ecology*, 18(3), 421-431.

- Tanikawa, H., Fishman, T., Okuoka, K., & Sugimoto, K. (2015). The weight of society over time and space: A comprehensive account of the construction material stock of Japan, 1945–2010. *Journal of Industrial Ecology*, 19(5), 778-7
- Taylor, M. A., Clarke, L. A., Centella, A., Bezanilla, A., Stephenson, T. S., Jones, J. J., . . . Charlery, J. (2018). Future Caribbean Climates in a World of Rising Temperatures: The 1.5 vs 2.0 Dilemma. *Journal of Climate*, 31(7), 2907-2926. doi:10.1175/jcli-d-17-0074.1
- Tompkins, E. L. (2005). Planning for climate change in small islands: insights from national hurricane preparedness in the Cayman Islands. *Global Environmental Change*, 15(2), 139-149.
- Tingley, D.D., Arbabi, H., & Durkin, M. (2017). The importance of understanding the material metabolism of the built environment presented at World Sustainable Built Environment Conference, Hong Kong, 2017.
- UNDESA (2014). Climate Change & Disaster Risk Management- Partnerships Briefs for Small Island Developing States.
https://sustainabledevelopment.un.org/content/documents/1344SIDS_BRIEFS_ClimateChange.pdf
- UNEP (2011). Decoupling natural resource use and environmental impacts from economic growth, A Report of the Working Group on Decoupling to the International Resource Panel. Fischer-Kowalski, M., Swilling, M., von Weizsäcker, E.U., Ren, Y., Moriguchi, Y., Crane, W., Krausmann, F., Eisenmenger, N., Giljum, S., Hennicke, P., Romero Lankao, P., Siriban Manalang, A., Sewerin, S.
- _____ (2011b). Sustainable Island Resource Management Zoning Plan (SIRMZP) for Antigua & Barbuda Including Redonda <http://wedocs.unep.org/handle/20.500.11822/9320>
- UNEP, UN DESA and FAO, 2012, SIDS-FOCUSED Green Economy: An Analysis of Challenges and Opportunities www.unep.org/greeneconomy and www.unep.org/regionalseas
- UNEP (2016). Global Material Flows and Resource Productivity. An Assessment Study of the UNEP International Resource Panel. H. Schandl, M. Fischer-Kowalski, J. West, S. Giljum, M. Dittrich, N. Eisenmenger, A. Geschke, M. Lieber, H. P. Wieland, A. Schaffartzik, F. Krausmann, S. Gierlinger, K. Hosking, M. Lenzen, H. Tanikawa, A. Miatto, and T. Fishman. Paris, United Nations Environment Programme.

- UN-OHRLLS., (2015). Small Island Developing States in Numbers: Climate Change Edition.
<http://unohrlls.org/sids-in-numbers-climate-change-edition-2015/>
- Vilaysouk, X., Schandl, H., & Murakami, S. (2017). Improving the knowledge base on material flow analysis for Asian developing countries: A case study of Lao PDR. *Resources, Conservation and Recycling*, 127, 179-189.
- Wallner, H. P., Narodoslawsky, M., & Moser, F. (1996). Islands of sustainability: a bottom-up approach towards sustainable development. *Environment and Planning A*, 28(10), 1763-1778.
- Wallsten, B., Magnusson, D., Andersson, S., & Krook, J. (2015). The economic conditions for urban infrastructure mining: using GIS to prospect hibernating copper stocks. *Resources, conservation and recycling*, 103, 85-97.
- Weaver, D. B. (1988). The evolution of a 'plantation' tourism landscape on the Caribbean island of Antigua. *Tijdschrift voor economische en sociale geografie*, 79(5), 319-331.
- Wiedenhofer, D., Steinberger, J. K., Eisenmenger, N., & Haas, W. (2015). Maintenance and expansion: modeling material stocks and flows for residential buildings and transportation networks in the EU25. *Journal of Industrial Ecology*, 19(4), 538-551.
- Wiedenhofer, D., Fishman, T., Lauk, C., Haas, W., & Krausmann, F. (2019). Integrating material stock dynamics into economy-wide material flow accounting: concepts, modelling, and global application for 1900–2050. *Ecological economics*, 156, 121-133.
- Wiesen, K., & Wirges, M. (2017). From cumulated energy demand to cumulated raw material demand: The material footprint as a sum parameter in life cycle assessment. *Energy, Sustainability and Society*, 7(1). doi:10.1186/s13705-017-0115-2
- Williams, J. (2019). The Circular Regeneration of a Seaport. *Sustainability*, 11(12), 3424
- World Meteorological Organization-WMO (2016). Climate Prediction for Small Island Nations: Managing Risks, Maximizing Opportunities. Retrieved from
<https://www.sprep.org/attachments/VirLib/Global/climate-prediciton-small-islands-nations.pdf>
- Yuan, Z., Bi, J., & Moriguichi, Y. (2006). The circular economy: A new development strategy in China. *Journal of Industrial Ecology*, 10(1-2), 4-8.
- Zhu, X. (2014). GIS and urban mining. *Resources*, 3(1), 235-247.

8 Appendix

8.1 Data Quality Assessment

To address the uncertainties presented in the trade data briefly outlined in Section 5.3 a data quality assessment was conducted through the use of the quality data indicators outlined in Table S1 and the respective results of the assessment shown in Table S2. This assessment table was sourced from the Metabolism of Islands' (MoI) website, which focuses on gathering data on the biophysical flows of resources in islands around the world. Data used and presented on the website is analyzed using the following table.

Table S1: Data quality indicators used in assessing the data uncertainty and reliability of the data sets used in the research.

Data Indicators	1	2	3	4	5
Reliability	Verified data based on measurements	Verified data partly based on assumptions or non-verified data based on measurements	Non-verified data partly based on assumptions	Qualified estimate (e.g. by industrial expert)	Non-qualified estimate or unknown origin
Completeness	Representative data from a sufficient sample of sites over an adequate period to even out normal fluctuations	Representative data from a smaller number of sites but for adequate periods	Representative data from an adequate number of sites but from shorter periods	Representative data but from a smaller number of sites and shorter periods or incomplete data from an adequate number of sites and periods	Representative data but from a smaller number of sites and/or from shorter periods
Access	Publicly and readily available data that requires little to no additional calculation	Publicly and readily available data that requires additional calculation	Data is not readily available (e.g. only after specifically requesting it from authorities) that requires little to no additional calculation	Data not readily available (e.g. only after specifically requesting it from authorities) that requires additional calculation	Data is very difficult to obtain if at all possible

Geographical Correlation	Data from area under study	Data from bigger or smaller area in which the area under study is included	Data from area with similar production conditions	Data from area with slightly similar production conditions	Data from unknown area or area with very different production conditions
---------------------------------	----------------------------	--	---	--	--

Table S2: Data Quality Results of the MFA Data Set.

Data Indicators	Trade Data	Material Intensity	Sea Level Rise Assessment
Reliability	2	4	3
Completeness	2	2	1
Access	1	3	3
Geographical Correlation	1	1	1

Table S3: Processing and Manufacturing Loss Rates of Key Building Stock Materials used in estimating loss rates of materials used in domestic extractions (DE) and the gross addition to stocks (GAS)

Stock-building materials (MFA)	Primary material inputs to stock	Uncertainty range (\pm three StdDevs)	Processing losses	Manufacturing Losses
Industrial roundwood	Solidwood	15%	10%	27%
Industrial roundwood	Paper and paperboard	15%		
Iron ore	Iron and steel	15%	42–58%	17.5%
Copper ore	Copper	15%	96–99%	2.7%
Bauxite	Aluminum	15%	80–86%	7.6%
Other ores and minerals	Other metals and minerals	15%	91–97%	9.2%
Crude oil/natural gas	Plastics	15%	n.d.	10%
Crude oil	Bitumen/asphalt	15%	n.d.	4%
Limestone, gypsum, clay	Cement/concrete	15%	44%	4%
Clay	Bricks	45%	26%	4%

Sand and gravel	Split into sand and gravel used in concrete and asphalt	60%	0%	4%
Not in database (see SI section 1.5)	Sand and gravel required as sub-base and base-course layer for road and building construction	60%	0%	0%

8.2 Material Intensity Typology Calculations

Concrete

1. Foundation

Calculate:

Footing

Find the mean distance of the footing, from the architectural drawing based on the engineering longitudinal specification = {d} (length)

The width of the footing = {w} (Usually 2ft)

The thickness of the concrete in the footing expressed in volume = {t} (8 inch is used within the footing)

Concrete = $d \times w \times t$ (cubic ft.)

- Conversion factor to cubic yard: Divide the volume by 27 for cubic yards.
- Conversions factor to tons: Multiply 1.35 per cubic yard for value in tons
- Convert ton to unit tonne: Divide the mass value by 1.102
- Convert Tonne to kg: Multiply the mass value by 1000.

Concrete in Vertical Members- Columns & Block Cavities.

Every steel will need to be covered in concrete within the block cavity and column cavity.

Columns work

Calculate concrete in vertical members:

- Columns: count the number of columns used and specified within the drawing. (NB: The different in size in each column then find the total number of columns in each one).
- Find the cross-sectional dimension and multiply each size to find the cross-section area.

- Then multiply it by the mean vertical height of the columns (they are different sizes such as: 8"x8", 12"x12" etc).
- Summary calculation: (the number of column) X (the cross-section area) X (the mean vertical height of the columns)

Block work

- A_c is the hollow cross-section area of the block which is referred to as the cavity. It is usually measured at 5"x5" for a 8" block)
- Find the mean vertical height of the block
- Find the number of cavities (A_c): "d" (mean distance of the footing) / spacing of the steel (in a typical foundation 2ft per center is usually used for this calculation and application)
- Summary Calculation: A_c x the mean vertical height of the block x Find the number of cavities

Calculate block work:

- Number blocks in the foundation: find the total linear footage of the foundation ("d") X the average height of the foundation, divided by the surface area of the block.

Dimension of the block

Size of the block = 8" X 8" X 16"

8 inches * 16 inches = 128 surface area square inches

128 square inch divided by 1550 = 0.89 surface area square meter

Number of steel bars in the foundation

d = center line distance

- A typical footing has 3 bars running parallel to each other (longitudinal)
- $d * 3$ is used to calculate the total number of steel bars running parallel to each other
- 90 degrees to d there are bars running from center to center (8 inch center- 0.68 ft (is the typical spacing of steel bars) divided into d = number of spacing running 90 degrees to d (transverse)
- Number of bars = number of spacing + 1
- 2ft is the typical depth of the foundation (strip)

- $d \times 3 =$ longitudinal steel bars

NB: In the foundation there are bars that are longitudinal and transversal

From the footing you need the bar that goes up into the block which are usually 2ft center
 $d/2\text{ft} =$ the number of bars from the footing into the floor slab

Number of spacing = $d/2$

Length of the bar = Mean height of foundation wall and footing thickness

Add for the corner: number of corners in a building $\times 3 \times 4$ (total tie length)

Add for steel laps in the foundation: any straight continuous distance that exceed 20 feet in foundation footing then multiply three times four (3×4); for example; 3 is the number of longitudinal bars in foundation and each one crosses over each other by 2ft ($2 \times 2 = 4$).

The total is calculated by adding the number of times that a straight distance exceeds 20 feet $\times 12$ (4×3)

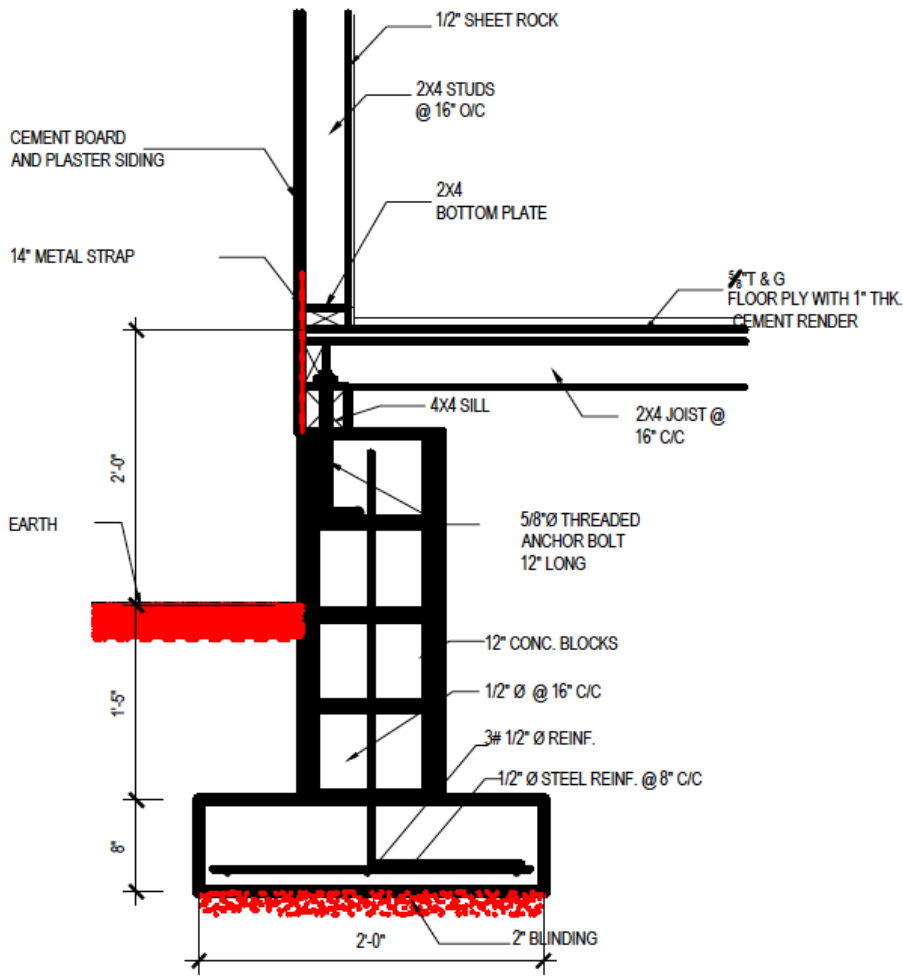

FOOTING DETAIL WOOD HOUSE

Figure S1: A detailed drawing of the footing detail of a wooden house

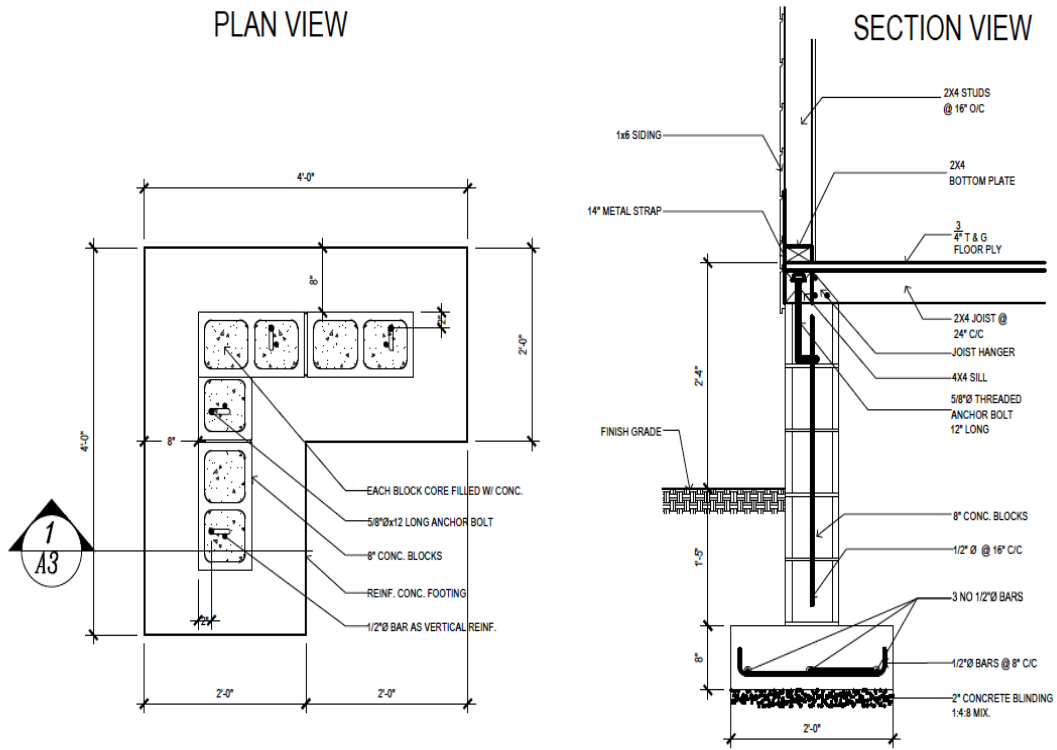

STRIP FOOTING ON CONCRETE PILLARS

Figure S2: A typical drawing of a strip foundation (with concrete pillars)

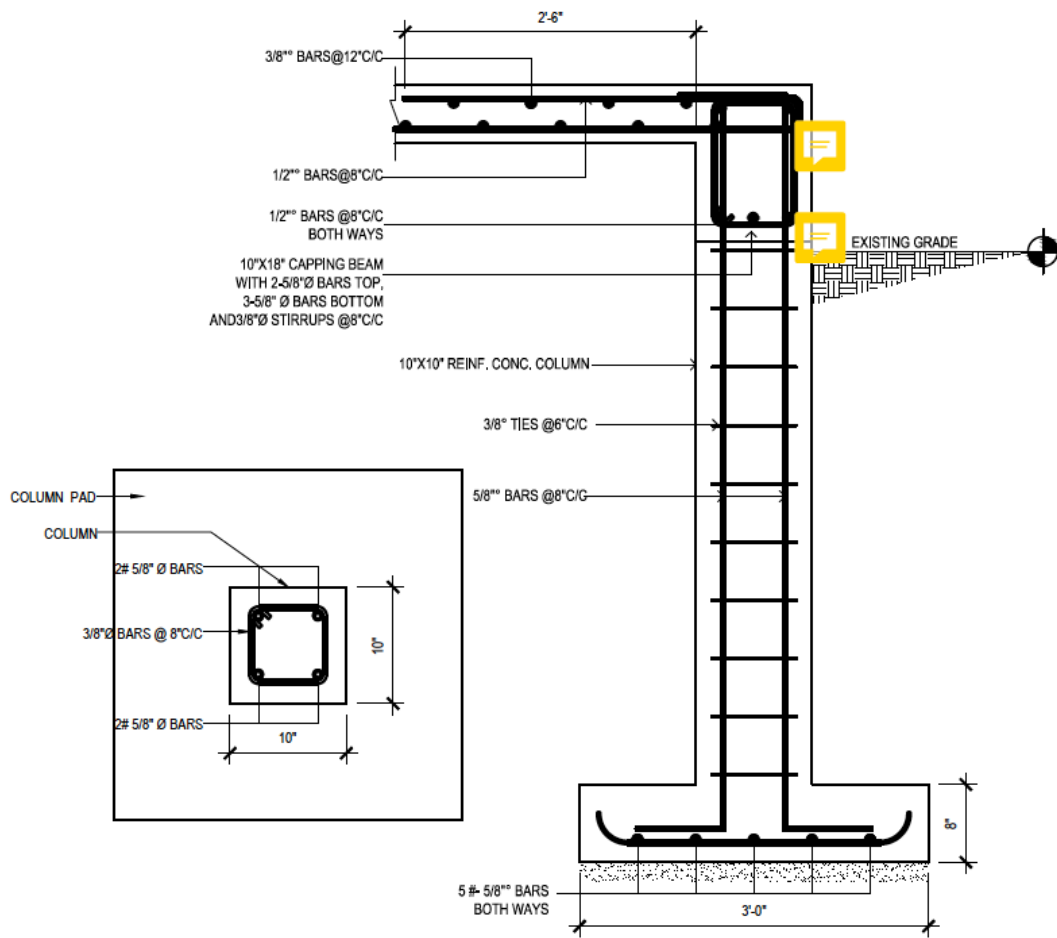

COLUMN PAD FOOTING

Figure S3: A typical drawing of a column pad footing

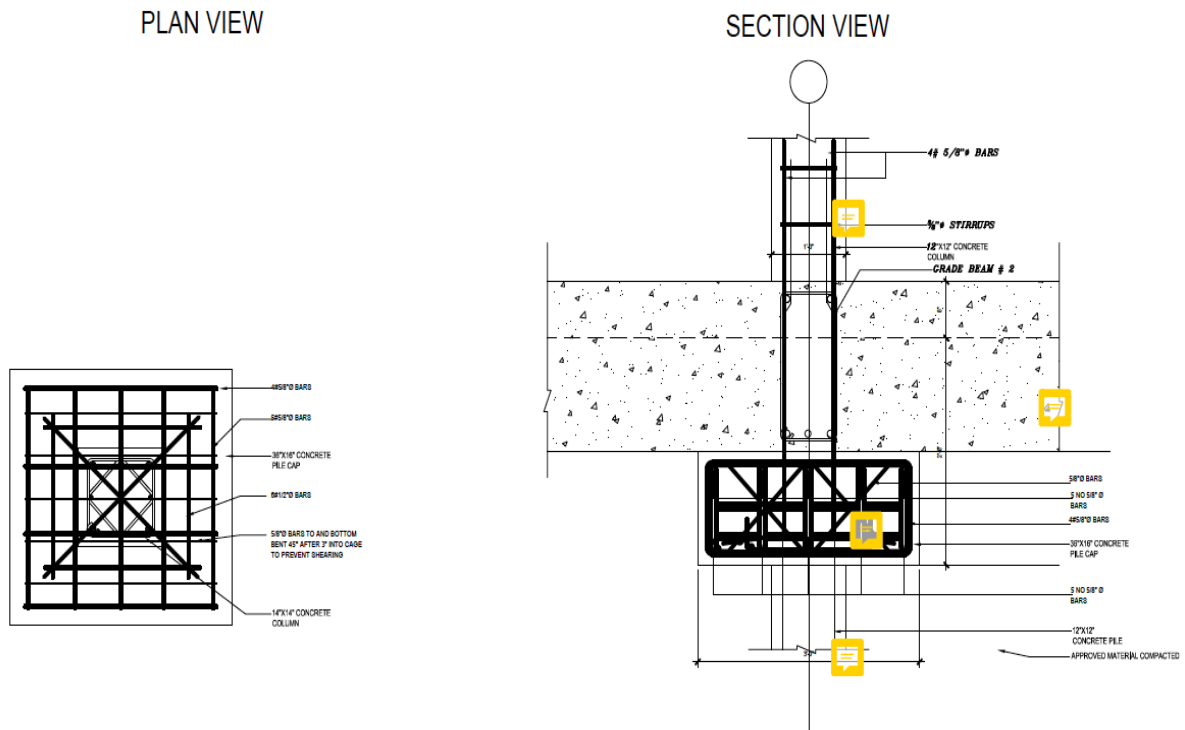

PILE CAP AND BEAM FOUNDATION

Figure S4: A typical drawing of a pile cap and beam foundation.

Aggregates.

Fine Aggregate- Sand

Sand is used in the production of concrete and the mixing of mortar.

Coarse Aggregates -stones

It is used in the production of concrete three sizes are usually used (3/8", 1/2" & 3/4")

Mortar is a paste utilized for binding building blocks including stones, bricks, and concrete masonry units, in order to fill irregular gaps

Mortar's two main application includes block laying and surface plastering.

Mortar mixture is consisting of a 1:3 ratio: one-part cement used with three parts of sand.

Composition of the Concrete:

- Stone is used mainly in the production of concrete, for both columns and block cavities.
- Concrete mixture is comprised of a 1:2:4 ratio. This includes, cement: fine aggregate: coarse aggregate.
- The strength of the concrete is estimated to be 3000 psi.

Concrete block

Usually 8” concrete blocks are used in the foundation.

- Size of the block = 8” X 8” X 16”
- 8” (thickness- determines the name of the block) X 8” (height- typical in all blocks) X 16” (length- typical in all blocks)

Number of Blocks = $[d \times h(\text{mean height of the block work})] / (1.33 * 0.67)$.

Number of Block = $(d \times h) / 0.89$

From a civil engineer and a quantity surveyor these calculations are 95% accurate for the purpose of the research. No columns within the block work

2. Ground and Floor Slab

Steel and Beam -

Re-calculate d_b for beams

Usually they are three different sizes of steel used in a typical residential buildings including: ½ “ steel; 3/8” steel and ¼” steel . In addition to 5/8” steel used for large spans.

Total length of ½” steel reinforcement bar = $d_b \times 4$ (or the number of main bars) + # of corners x 4 + # of times the span exceed 20 ft) X 4

Total length of 3/8” steel = $d_b / \text{spacing of the link} \times \text{the length of each link}$.

NB: Links are reinforcing steel rectangular links

Floor Slab

Divide the total area into rectangles. For each rectangle, calculate the following:

Assume the rectangle sides are z and y.

Total length of 3/8" = $(z1/spacing) * y2 + (y1/spacing) * z + ((z2/spacing)*y2 + (y2/spacing)*z2)$

Concrete

Calculation of concrete volume in a Beam = d length x beam width x (beam depth-slab thickness).

Calculation of concrete volume in a Slab = the area of the floor x thickness of the floor slab.

Suspended floor Slab.

Steel and Beam -

Re-calculate the total distance d_b for beams

Total length of 5/8" steel reinforcement bar = $d_b \times 4$ (or the number of main bars) + # of corners X 4 + # of times laps (when the span exceeds 20t) X 4

Total length of 3/8" steel = $(d_b / spacing \text{ of the link}) \times \text{the length of each link}$.

Divide the total area into rectangles. For each rectangle, calculate the following:

Assume the rectangle sides are z and y.

Total length of 1/2" = $((z1/spacing) * y2 + (y1/spacing) * z) + ((z2/spacing)*y2 + (y2/spacing)*z2)$

3. Walls.

Steel in Walls (for the foundation and above the foundation).

Vertical steel for all block work including for the superstructure (walls above the foundation) and the substructure (foundation walls) .

Assume 1/2 inch reinforcement steel bar is being used.

Total steel length (TSL) = $(d / spacing \text{ (for foundation 2 feet and upper walls 2' - 8")})$.

Multiply the mean height of the wall (foundation typ. 2'-8" and above the foundation 8').

Therefore (TSL) = (d/s) X h, (conversion from the # of length of ½ steel to one ton of steel (from length to weigh) t - ½ “steel, 188 inches length = 1 ton

Aggregates in Block Work

Fine aggregates (sand)

Sand is used in the production of concrete and mixing of mortar. As mentioned previously mortar has two main applications. The mortar is mixed in a 1:3 ratio; 3-part sand and 1-part cement.

Coarse aggregate (3/8” and ½” crush tone).

Stone is used mainly in the production of concrete for both columns and block cavities.

Work studies have shown that for 25 8” blocks would require 1 bag (94.4 lbs) cement in foundation.

Additional 30-6” blocks would require 1 bag of cement in walls above the foundation (superstructure).

NB Concrete mixture and strength is as previously mentioned.

Example: if you calculate for 1000-8” blocks, then the number of cement = $1000/25 = 40$ bags.

Therefore:

Cement 94 lbs = 3760 lbs

Sand 2 parts = 7520 lbs

Stone 4 parts 15040 lbs

For sand, we usually used 3 parts in the calculation since in mortar the ratio is 1:3.

Therefore, sand should be 11280lbs – for consistency in calculation for most in the industry used 1:3:4.

Roof

Assume a slope of 5 inches vertically and 12 inches horizontally across, which is expressed as a 5/12 slope. In other words, there is a slope distance of 13 inches at a right angle (5’12’13’).

Therefore, the number of rafters = length of the spacing?

Length of the rafters is = $(13/12) \times b/2$ where:

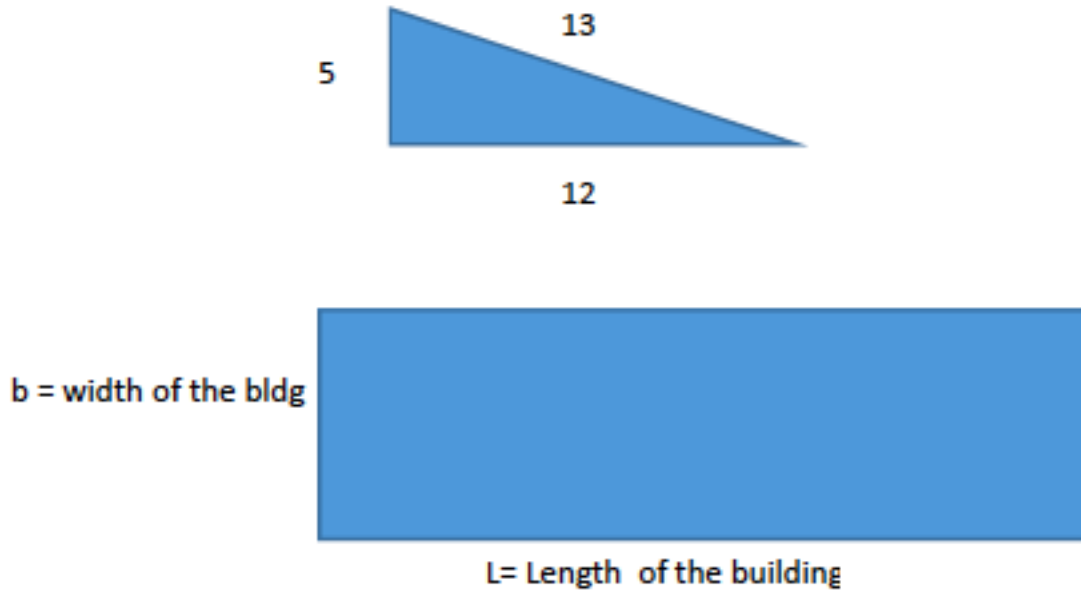

Figure S5: Typical measurement of a slope of a house

Length of the rafter = $(13/12) \times b/2$

Example: If a building is 36 ft long x 20 ft wide

Common rafter spacing is 2ft on center

#spacing (2" x 6") on one side = $36/2 = 18$

rafter = spacing + 1 but calculated for two sides.

Therefore = $19 * 2 = 38$

Length of the rafter is $(13/12) \times 20/2 = 10.83$ ft

With an overhand on each rafter then the use of 12 feet rafters # of 2" x 6" x 12'-Dpp (dress pitch pine) = 38

Fascia = $2(b + L)$

Fascia = $2(36 + 20) = 112$

Use 2' x 8' x 20' = 6.

Ridge = 36 ft

Use 2' x 8' x 18' = 2

Boarding

Roof area 36 x 10.83 x 2 (2 sides) = 783.36 sqft

T1-11 plywood is 32 sq.ft

Ti-11 plywood = 25

Plywood is positioned on a 12inch angle on the horizontal plane

Plywood is positioned at a 5inch angle on the vertical plane.

NB: Assumptions made based on the structure of a typical Gable roof.

Roof and Ring Beam

After the walls have been constructed there is a ring between the wall & roof. The calculations are as follows:

Concrete

Beam = d(b) x Beam width x beam depth

Convert to cubic yard divide by 27.

Convert to ton

Convert to kg

Example* Concrete in beam = d x .5 (6'' block) x 1.5 (12'' beam plus 6'' between rafters)

For d = 250 ft: concrete = (250 * .5 * 1.5) / 27 = 6.944 cubic yards

NB Common rafter in roof is typically 2'' x 6'' x length (See below)

There are six types of wood members that are used in buildings:

- Common rafter is main wood member that span between the building wall and the apex of the roof (2 x 6 but a wooden small house uses 2 x 4)
- Fascia is a horizontal member at the perimeter of roof framing (2'' x 8'').
- Hip & valley rafters are main supporting sloping rafter (2'' x 8'')
- Ridge rafter is located at the apex of the roof horizontal (2'' x 8'').

- Purlin wooden member between boarding and roofing galvanize

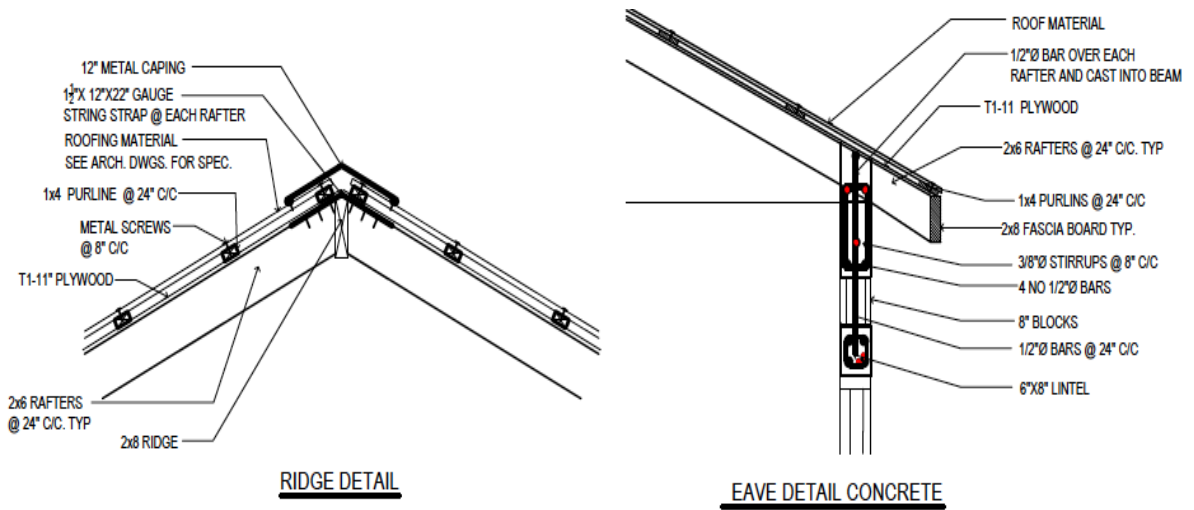

Figure S6: Illustrates the individual roof details of a typical Gable roof.

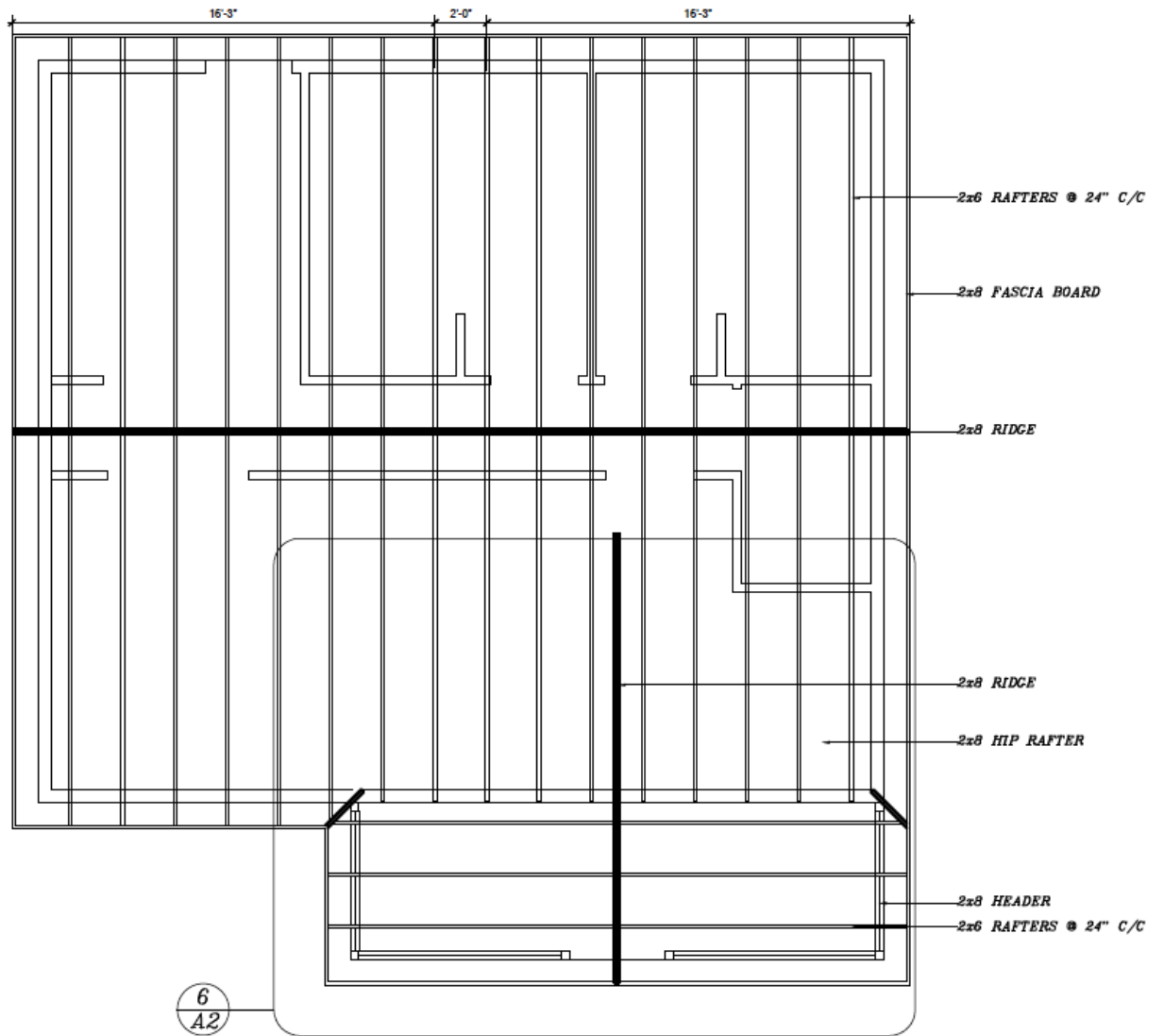

Figure S7: An aerial view of a typical Gable Roof

8.3 Code used in the Monte Carlo Simulations for the Random Assignment of Material Intensity Typologies within the Residential Sector

#Set the workspace directory- to specify the pathway for access to the desired work folder for R-studio.

```
setwd("N:/New folder")
```

#Import the csv file containing the residential building footprints. This csv file should include headings with the Gross Floor Area (GFA), Index, Material Intensities (MI) and Material Stocks (MS) separated by the individual material category (Aggregates, Concrete, Timber, Steel) and the sum of the Material Stocks.

```
df <- read.csv("ResiMIJB.csv", header = TRUE, dec = ".")
```

#Create a separate results table to capture the results components that are of interest. In this scenario, this included the Material Stocks separated by material category and the sum of Material Stocks.

```
results <- data.frame()
x <- c("MSAggSum", "MSTimberSum", "MSConcSum", "MSSteelSum",
      "TotalMSSum")
##LOOP START##
counter <- 10
# repeat{
  for (i in 1:counter){
```

#Distribute the material intensities through creating an index comprising of “A, B, C, D, E”, which reflects the probability used to assign the MI to the individual building footprints. The distribution of the material typologies was defined beforehand based on census data to be implemented in the code (Table 7).

```
y <- sample(LETTERS [1:5],51406,replace=TRUE, prob =c(0.13,0.15,0.02,0.50,0.20))
df$Index <-y
#letters <- c("A", "B", "C","D", "E")
```

```

#Define df$Index and corresponding material stock values
df$MIAgg12 <- ifelse(df$Index == "A", 0.18619, ifelse(df$Index == "B", 0.2199,
ifelse(df$Index == "C", 0.10995, ifelse(df$Index == "D", 0.10995, 0.2216))))
df$MITimber <- ifelse(df$Index == "A", 0.02399, ifelse(df$Index == "B", 0.02467,
ifelse(df$Index == "C", 0.02425, ifelse(df$Index == "D", 0.02771, 0.02086))))
df$MIconc12 <- ifelse(df$Index == "A", 0.61082, ifelse(df$Index == "B", 0.64515,
ifelse(df$Index == "C", 0.67195, ifelse(df$Index == "D", 0.11744, 0.40935))))
df$MISteel1 <- ifelse(df$Index == "A", 0.06751, ifelse(df$Index == "B", 0.08237,
ifelse(df$Index == "C", 0.06711, ifelse(df$Index == "D", 0.04998, 0.06709))))

```

#Calculate the MS with respect to the individual material categories: for each building footprint. The material stock of material i is calculated as follows: $MI_i \times GFA_i$; i is the GFA of a residential building footprint (Section 3.7)

```

df$MSAgg <- df$MIAgg12 * df$GFA
df$MSTimber <- df$MITimber * df$GFA
df$MSConc <- df$MIconc12 * df$GFA
df$MSSteel <- df$MISteel1 * df$GFA

```

#Calculate the total MS for the individual Building footprint

```
df$TotalMS = df$MSAgg + df$MSTimber + df$MSConc + df$MSSteel
```

Calculate the sum of all columns (MS of Aggregates, Timber, Concrete, Steel and the Total MS) in each iteration out of the total number of iterations being run in the code. One iteration contains 51,406 building footprints.

```

dfout <- data.frame(ncol=5,nrow=counter)
colnames <- x

dfout$MSAggSum <- sum(df$MSAgg)
dfout$MSTimberSum <- sum(df$MSTimber)
dfout$MSConcSum <- sum(df$MSConc)

```



```

dfout$MSSSteelSum <- sum(df$MSSSteel)
dfout$TotalMSSum <- sum(df$TotalMS)

results <- rbind(results, dfout)
##LOOP END##
}

write.csv(results, "Results.csv").

```

8.4 Timeline of Hurricanes and Tropical Storms in A&B from 2006-2017.

The storms are identified by their name, the year they occurred, the strength of the storm (Tropical Depression, Category 1-5 hurricane) and the type of strike.

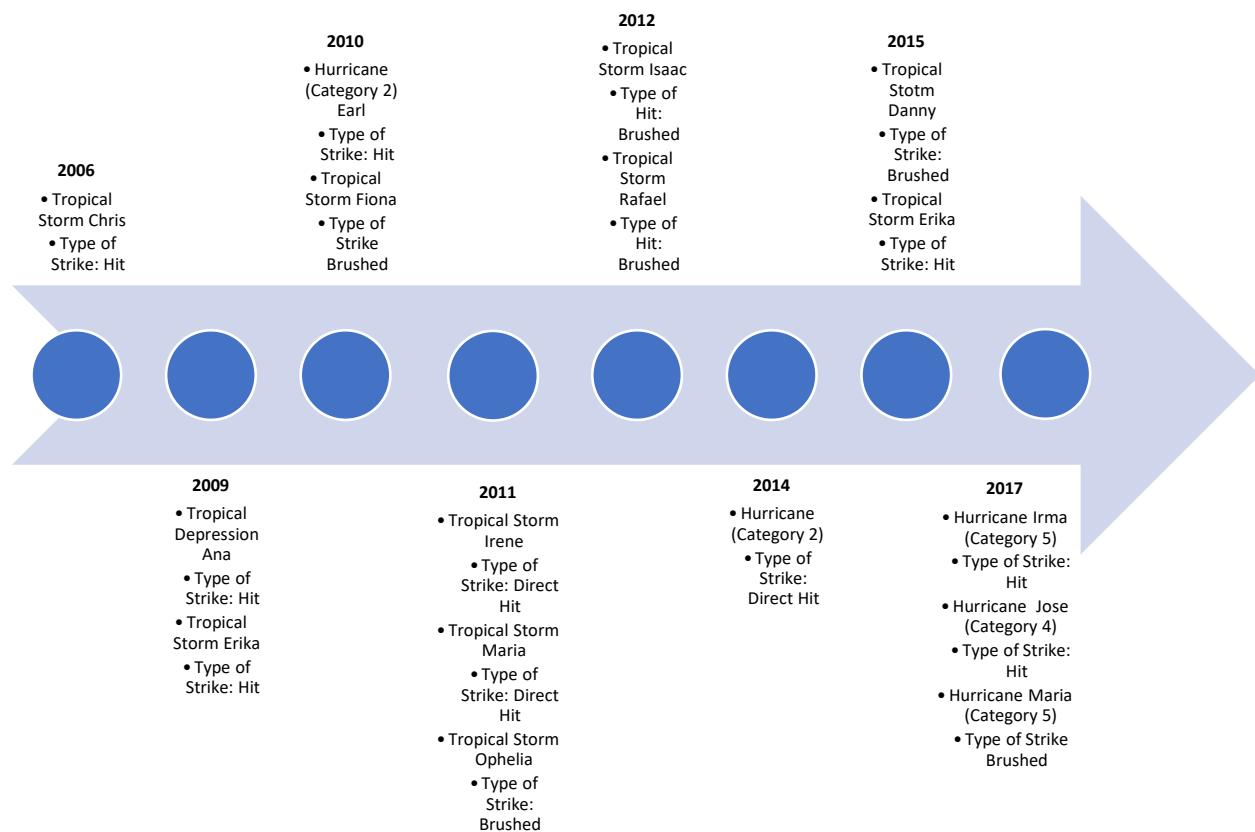

Figure S7: Hurricanes Experienced between 2006-2017 in Antigua & Barbuda

Type of Strike:

Direct Hit: The cyclone centre passed over land or at most 15 nautical miles from land

Hit: The cyclone centre passed between 15 and 65 nautical miles from land

Brushed: The cyclone centre passed between 65 and 105 nautical miles from land

8.5 Tourist arrivals compared with local population.

Tourist arrivals into Antigua & Barbuda are separated within three categories including air, cruise, and yacht. Throughout 2006 and 2017, tourist arrivals are 90% (average) greater than the island’s population size. This speaks to the extent of tourist entering the country’s boundary and the magnitude of material stocks that are needed to accommodate the tourist arrival.

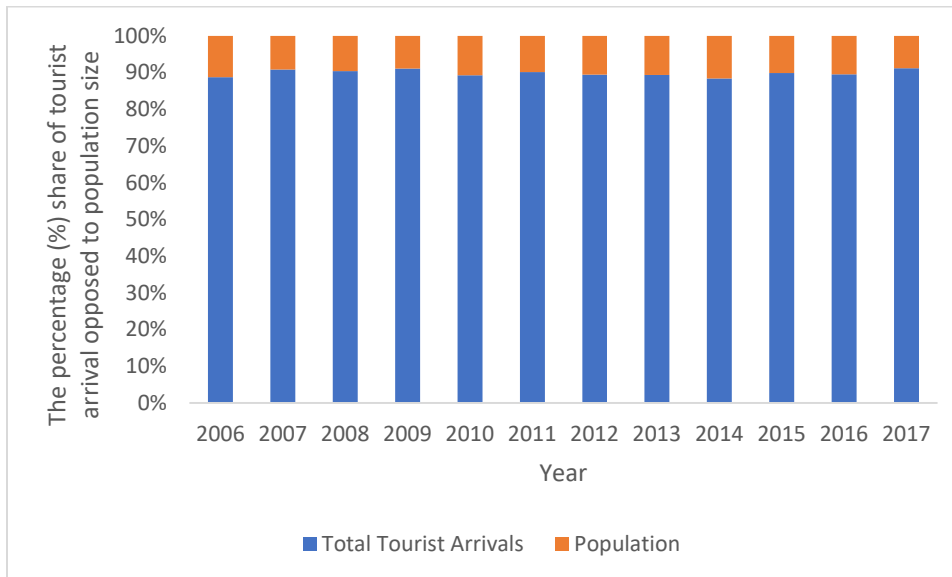

Figure S8: The percentage (%) share of tourist arrival opposed to population size in Antigua and Barbuda from 2006-2017

8.6 Construction Material Codes and Description.

Table S4: A Table of the construction materials codes and description of Material studied within the study sourced from the UN Comtrade database.

HS Code	Description of Material
Wood	
4403	Wood in the rough or roughly squared
4404	Hoopwood, split poles, pile, pickets and stakes
4406	Railway or tramway sleepers (cross-ties) of wood
4407	Wood sawn, chipped lengthwise, sliced or peeled
4408	Veneers and sheets for plywood etc <6mm thick
4409	Wood continuously shaped along any edges
4410	Particle board, similar board, wood, ligneous material
4411	Fibreboard of wood or other ligneous materials

4412	Plywood, veneered panels and similar laminated wood
4413	Densified wood, in blocks, plates, strips or profile
4418	Builders joinery and carpentry, of wood
441840	Shuttering for concrete constructional work, of wood
441850	Shingles and shakes, of wood
Iron & Steel	
7207	Semi-finished products of iron or non-alloy steel
7208	Hot-rolled products, iron/steel, width>600mm, not clad
7209	Flat-rolled iron/steel, >600mm, not clad, plated, etc
7210	Flat-rolled iron/steel, >600mm, clad, plated or coated
7211	Flat-rolled iron/steel, <600mm, not clad, plated, etc
7212	Flat-rolled iron/steel, <600mm, clad, plated or coated
7213	Hot rolled bar, rod of iron/steel, in irregular coils
7214	Iron/steel bar, only forged hot-rolled drawn, extruded
7215	Bar and rod of iron or non-alloy steel nes
7216	Angles, shapes and sections of iron or non-alloy steel
7217	Wire of iron or non-alloy steel
7218	Stainless steel in primary forms, semi-finish products
7219	Rolled stainless steel sheet, width > 600mm
7220	Rolled stainless steel sheet, width < 600mm
7221	Bar or rod of stainless steel, hot rolled, coiled
7222	Bar, rod nes, stainless steel, angles, shapes/sections
7223	Wire of stainless steel
7224	Alloy steel in ingots in primary form or semi-finished
7225	Flat-rolled alloy steel nes, width >600mm
7226	Flat-rolled alloy steel nes, <600mm wide
7227	Bar, rod, hot-rolled alloy steel, irregular coils nes
7228	Bar, rod, angle etc nes, hollow steel drill bars
7229	Wire of alloy steel except stainless steel
7301	Sheet piling, welded angles, sections of iron or steel
7302	Railway and tramway track material of iron or steel
7303	Tubes, pipes and hollow profiles, of cast iron
7304	Tube or hollow profile, seamless iron/steel not cast
7305	Pipe, welded, riveted iron or steel, diameter >406.4mm
7306	Tube, pipe of iron or steel, except seamless > 406.4mm
7307	Pipe fittings, of iron or steel
7308	Structures, parts of structures of iron or steel, nes
7309	Reservoirs, tanks, vats, etc, iron or steel cap >300l
7310	Tank, cask, box, container, iron/steel, capacity <300l
7311	Containers for compressed, liquefied gas, iron, steel
7312	Stranded steel wire, cable/etc, no electric insulation
7313	Wire for fencing, including barbed wire
7314	Iron or steel cloth, grill, fencing and expanded metal

7315	Chain and parts thereof, of iron or steel
7316	Anchors, grapnels and parts thereof, of iron or steel
7317	Nails, staples, etc, iron/steel, not office stationery
7318	Screws, bolts, nuts, rivets, washers, etc, iron, steel
7319	Sewing, knitting needles, etc, hand use, iron or steel
7320	Springs and leaves for springs, of iron or steel
7321	Stoves, ranges/barbecues, non-electric, iron/steel
7322	Radiators, non-electric heaters (with fan), iron/steel
7323	Table, kitchen, household items of iron or steel nes
7324	Sanitary ware and parts thereof, of iron or steel
7325	Cast articles, of iron or steel nes
7326	Articles of iron or steel nes
Other Metals	
7403	Refined copper and copper alloys, unwrought
7407	Copper bars, rods and profiles
7408	Copper wire
7409	Copper plates, sheets and strips, thickness > 0.15mm
7411	Copper pipes, tubes
7412	Copper pipe and tube fittings
7412	Copper pipe and tube fittings
7413	Stranded copper wire, cable, plaits, etc, uninsulated
7414	Copper wire cloth, grill, netting, expanded metal
7415	Copper nails, screws, bolts, pins, washers, etc
7417	Copper cooking, heating apparatus, non-electric, parts
7418	Copper table, kitchen, household and sanitary items
7419	Articles of copper nes
7501	Nickel matte, interim products of nickel metallurgy
7505	Nickel bars, rods, profiles and wire
7507	Nickel tubes, pipes and tube or pipe fittings
7508	Articles of nickel, nes
7601	Unwrought aluminium
7603	Aluminium powders and flakes
7604	Aluminium bars, rods and profiles
7605	Aluminium wire
7606	Aluminium plates, sheets and strip, thickness > 0.2 mm
7607	Aluminium foil of a thickness < 0.2mm
7608	Aluminium tubes and pipes
7609	Aluminium tube or pipe fittings
7610	Aluminium structures, parts nes, for construction
7611	Aluminium reservoirs, vats, tanks, etc, capacity >300l
7612	Aluminium casks, drums, boxes, etc. capacity <300l
7613	Aluminium containers for compressed or liquefied gas
7614	Aluminium stranded wire, cables, plaits, uninsulated
7615	Aluminium ware for table, kitchen, sanitary use

7616	Articles of aluminium nes
7801	Unwrought lead
7803	Lead bars, rods, profiles and wire
7806	Articles of lead nes
7904	Zinc bars, rods, profiles and wire
7905	Zinc plates, sheets, strip and foil
7906	Zinc tubes, pipes and tube or pipe fittings
7907	Articles of zinc nes
8007	Tin articles nes
Non-metallic Minerals	
2505	Natural sand except sand for mineral extraction
2506	Quartz (except natural sands) and quartzite
2507	Kaolin and other kaolinic clays
2508	Clay nes (except expanded clay for insulation)
2514	Slate
2515	Marble, travertine, ecaussine etc
2516	Granite, porphyry, basalt, sandstone, etc.
2517	Pebbles, gravels, aggregates and macadam
2518	Dolomite
2520	Gypsum, anhydride, gypsum plaster
2521	Limestone materials for manufacture of lime or cement
2522	Quicklime, slaked, hydraulic lime for construction etc.
2523	Cement (portland, aluminous, slag or hydraulic)
2714	Bitumen, asphalt, oil shales, tar sands, asphaltites
6801	Stone setts, curbstones, flagstones (except slate)
6802	Worked monumental, building stone, articles thereof
6803	Worked slate, agglomerated slate, articles thereof
6807	Asphalt, bitumen, coal tar pitch, etc articles
6808	Boards etc of vegetable fibre, mineral binder, cement
6809	Articles of plaster or plaster-based compositions
6810	Articles of cement, concrete or artificial stone
6811	Articles of asbestos-cement & cellulose fibre cement

8.7 Database of collected information for Antigua & Barbuda

Table S5: A database of collected information on Antigua & Barbuda used for data analysis.

Data Table: For Antigua & Barbuda						
Data Layer	Description	Source	Year	Data Type	Vector/Raster	Status
Tourist arrival by air	The total number of stayover arrivals were reported annually for the previous decade. The average length of stay for North American and European visitors were reported.	Ministry of Tourism, Antigua and Barbuda Tourism Authority	1998-2004, 2006-2017	Table		Collected
Tourist Arrival by sea (Cruise ships and Yachts)	Tourist arrivals via ships and yachts were reported separately for the previous decade. NB Ships vary in size carrying less than 100 passengers while others carry over 4 thousand.		1998-2004, 2006-2017	Table		Collected
Type of dwelling unit	The different types of dwelling units present in each parish. Including, townhouse, business and dwelling etc...	The National Census	2011, 2001	Table		Collected
Type of material for outer walls	7 main categories of materials used for the outer walls of dwelling units in each parish was identified. They include concrete and blocks, stone, stone and brick, wood, and other material, improvised/makeshift and other.		2011, 2001	Table		Collected
Main Roofing Material	The type of roofing material of dwelling units within each parish was identified. It contained 7 different categories of roofing material used including: concrete, Improvised/makeshift, shingle (asphalt, wood, other), tile, tarpaulin, sheet metal, and other)		20,112,001	Table		Collected

Waste Receipts	The amount of waste collected annually, measured in tonnes within the time period of 2006-2017. The waste receipts are categorized into 11 categories. They include household, commercial, institutional, medical, construction and demolition, clean bulk, bulk waste, cruise ship, street sweep and tyres.	The National Solid Waste Management Authorities.	2006-2017	Table, Excel sheet		Collected
Tropical Storm Waste Volume	The volume of bulk waste collected after tropical storm Gonsalzo (recorded in tonnes)		2014	Table, excel sheet		Collected
Hurricane Records	Antigua tropical Cyclones with the dates the storm affected Antigua, the stage of the cyclone when it affected Antigua. Impact of the storm, a direct hit, hit, or if it was a brushed impact. In addition to information on wind speed, and direction given for each cyclone.	Antigua & Barbuda Meteorological Services	1964-2017	Table		Collected
Land Use Map	Identifies 14 different categories of land use within the island.	Department of Environment	2010	GIS Layer		Collected
Elevation	Elevation		2010	Gis Layer	TIN File	In progress
Building Layer	Building Layer		2010	GIS Layer	Vector	Collected
Major Tourism Facilities	Map showcasing the location of resort hotels, tourism activity areas, villas and cottages, ports, marinas, and airports on the island		2010	GIS Layer	Vector	Collected
Road Networks	Road Network utilized on the island		2010	GIS Layer	Vector	Collected
Environmental Risks & Areas	Indicates areas throughout the island that are threatened by a flood, erosion and slope risk		2010	GIS Layer	Vector	Collected

Building Footprints	Building Footprints from aerial imagery	Open Street Map		GIS Layer	Vector	Collected
Domestic Exports and Re-exports	Domestic exports and re-exports of commodity codes under the 3 categories of "wood", "iron and other materials, and "non-metallic minerals". NB: Records start from 2005, those from prior years are unavailable, in addition to the unavailability of trade flow data in 2008.		2005-2007, 2009-2017	Table		Collected
Imports	Imports of commodity codes under the 3 categories of "wood", "iron and other materials, and "non-metallic minerals". NB: Records start from 2005, those from prior years are unavailable, in addition to the unavailability of trade flow data in 2008.	Statistic Division	2005-2007, 2009-2017	Table		Collected
Height Data	(# of floors)	Field Work	2018	# of floors		Collected
Material Intensity Typologies	Establish material intensity typologies reflective of the local construction style.	Field Work & Local Consultation with civil engineers	2019	Document		Collected
Trade Data	Import, Export, Re-export data	UN Comtrade	1999, 2009, 2011, 2014, 2017	Table		Collected
Building Code	Detailed information on permits and fees, application to build, weights of building material, types of construction.	OECS	1992	Document		Collected
Building Permits	The number of building permits submitted and approved in addition to the total number pending, monthly. They were categorized into two categories Residential and	DCA	2006-2017	Table, Excel sheet		Collected

	Commercial. It detailed additional information on the square footage and estimated value within each category. Separated into two categories: one for new buildings and two for new additions.					
The national planning act	Building procedures and requirements. Outline land use developmental guidelines.	Development Control Authority	2003	Document		Collected